



Kodak LENS

LENS MANUAL

KODAK LENS INTRODUCTION

DISCOVER LEADING LENS TECHNOLOGY
AND EXCEPTIONAL BUSINESS SUPPORT

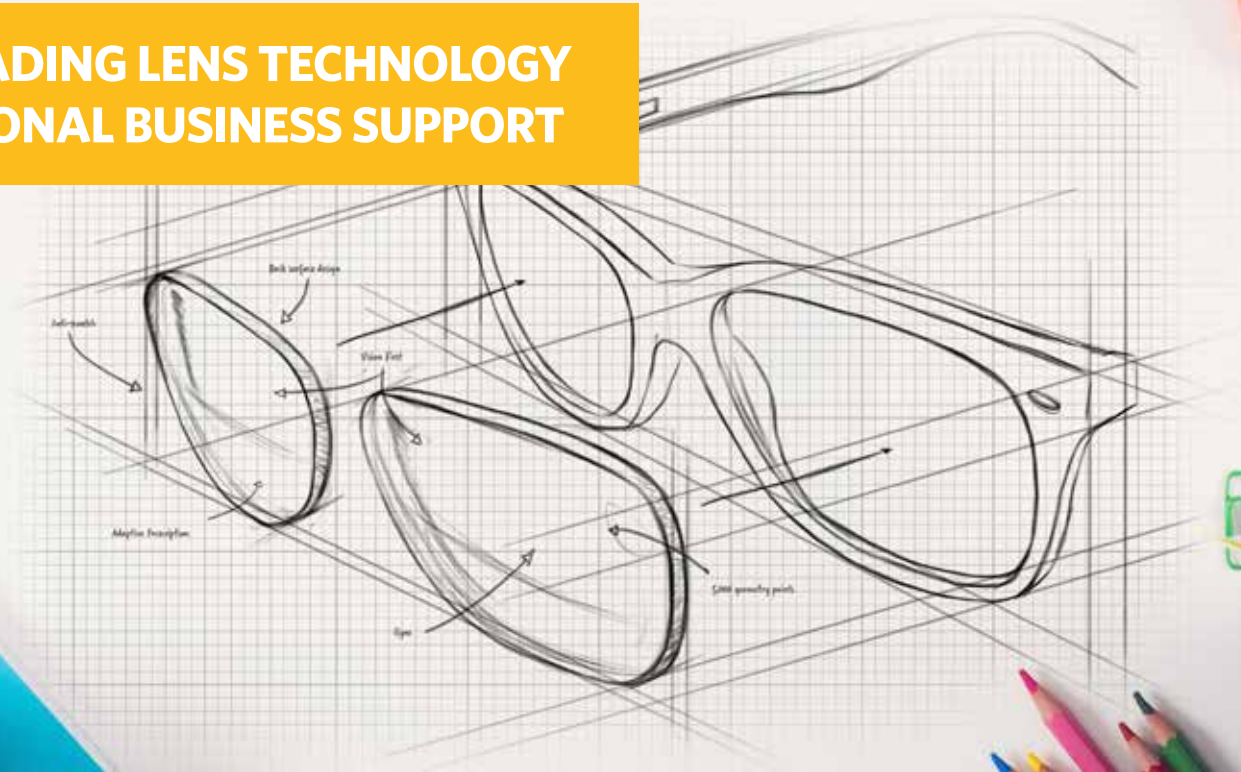



**SEE THE
COLOURS
OF LIFE**



**RETAIN 100% OF YOUR
INDEPENDENCE WITH
THE BACKING OF A
TRUSTED AND ICONIC
GLOBAL BRAND**

Kodak has a truly global consumer awareness. It's an awareness that speaks of value, quality and leading technology.



**KODAK LENS BELIEVES IN HELPING
LOCAL INDEPENDENT OPTICIANS THRIVE
THROUGH INNOVATIVE PRODUCTS AND
DEDICATED BUSINESS SUPPORT.**

QUALITY GUARANTEED



Every lens ordered with KODAK Clean&Clear, KODAK BluProtect or KODAK Clean&Clear UV on or after 28th August 2015 will be supplied with a 'no quibble' anti-scratch guarantee valid for 2 years.

This is separate to our standard guarantee against manufacturing defects. Under this guarantee, if your patient scratches their lenses all they have to do is return them to you and we will replace them FREE OF CHARGE. Sensible terms and conditions apply of course, see our 'Lens Finishes' booklet for full details.



KODAK LENS REWARDS

KODAK Lens Rewards turns your lens spend into points that can be used to purchase a wide range of benefits. You can log in at any time and review how many points you have earned, spent and have remaining. You can even view new benefits and add them to a wish list to be purchased another day. KODAK Lens Rewards has been designed to offer your business real value and tangible support.

BENEFITS TO YOU

- Equipment vouchers and special discounts
- Marketing campaigns
- Practice sundries
- Credits for the KODAK Lens Web2Print
- Shopping vouchers

For more information about KODAK Lens Rewards, please contact your regional manager.



FULL SERVICE MARKETING SUPPORT

Wouldn't it be great if you had a full service marketing agency on hand who specialise in communication with optical patients?

The KODAK Lens marketing team features skills and experience in every area of marketing.

BENEFITS TO YOU

- Local marketing & PR
- Free graphic design
- Advertising
- Patient promotions
- Website support
- Retail advice
- Digital marketing
- Creative ideas
- Marketing advice

If you know what you need to achieve, but you're not sure how to get there, give us a call on **01452 887 410**.



KODAK LENS WEB2PRINT

As a KODAK Lens customer you'll benefit from access to our online marketing resources and web-to-print service.

One login gives you access to a growing database of practice marketing ideas and materials.



BENEFITS TO YOU

- Personalise printed posters and brochures with your practice details or special offer, hit the 'print' button and receive your personalised marketing materials within 3-10 days
- Quick and simple to organise mail shots to your patients
- Spend KODAK Lens reward points on marketing for your practice
- Choose, edit and print virtually any marketing materials
- See available KODAK Lens marketing materials, merchandise and dispensing aids
- Quick print and delivery times (usually 5 days)
- Discounted prices for all materials

PROFESSIONAL SERVICES TRAINING

If we said our Professional Services team could raise the revenue of your practice by over 40% in a few months, would you be interested? That's exactly what can and has happened with other opticians who have decided to find out more.

Our team work with yours to study the patient journey, looking at things such as terminology, recommendations and the handover process. Practice staff will be left feeling empowered and eager to forget 'good, better, best' or concerns over price and instead focus on providing the best visual solution for every patient; this in turn will help patients realise your staff are trained eye care professionals, not sales assistants.

If you would like to know more please contact your regional sales manager or Rebecca Strutt on **01452 887 173 / 07860 320 068** or email rebecca.s@kodaklens.co.uk



DISPENSING TOOL (IDS)

KODAK Lens Intelligent Dispensing Software (IDS) incorporates all measuring devices into one easy to use tablet allowing you to gain highly accurate results on parameters for Monocular PDs, Heights, Pantoscopic Tilt, BVD and Dihedral Curve.

A built-in patient questionnaire collects basic lifestyle information before highlighting relevant products which can result in a higher average sale value. The IDS also allows patients to clearly see the visual benefit of premium lenses, such as thinner and lighter lenses. The dispenser can easily demonstrate the different edge thicknesses across the lens material range, making an upgrade to thinner lenses an easier conversation to have.

Full training is available to you for free, for more information please contact Rebecca Strutt by calling **01452 887 173 / 07860 320 068** or email rebecca.s@kodaklens.co.uk



ONLINE ORDERING & REMOTE EDGING

You will find the KODAK Lens online ordering system familiar and easy to use. Via an easy two-step process you can trace the patient's frame and place your order online with full tracking capability from start to finish.

We are able to process shapes from most tracers currently on the market and can accept a large number of different frame and prescription combinations. For frames that are difficult to trace accurately or lens powers that are +/- 6.00 with up to 3.00 cyls we recommend you send the complete order into our world class glazing department.

We recommend you use a surfaced lens for supra frames, please contact us for further advice.

UNSUITABLE FRAMES

We do not recommend you trace any of the following frame types if you require the lenses to be remotely edged. The frames do not produce good results due to the nature of the materials used or the actual design of the frame. We will however, use the frame trace for reducing thickness on uncut lens orders only.

1. Titanium metal frames
2. Double rim metal frames
3. Thin flexible plastic frames
4. Inline metal supra frames
5. Frames with a B measurement of less than 23mm
6. Wrap frames or frames with a wrap angle of more than 10°

If you have any queries, please call the K2 Helpline **01452 887 430**

Disclaimer Signet Armorlite Europe Ltd will not accept responsibility for poor fitting or edge finish for any orders placed outside of these guidelines and all rectification work or returns will be chargeable. By submitting a trace order the user is accepting responsibility to ensure the trace shape and measurements are accurate. Signet Armorlite will not accept liability for incorrect measurements and customer will be charged accordingly for any corrections.



KODAK LENS TECHNOLOGY

The following pages are dedicated to the industry leading technology that goes into every KODAK Lens product. These advanced technologies are briefly summarised in a handy table below, but if you have time we'd recommend you turn the page and get into the gritty details of what makes our lenses great. You won't be disappointed.

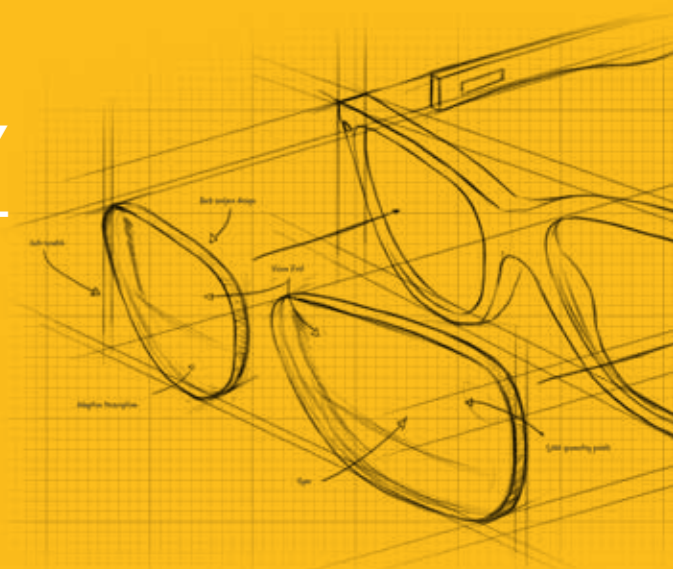

Lens Technology	Feature	Benefit	Concise Digital	Precise Digital	Easy	Unique	Unique HD
Digital Freeform Lenses	Digital surfacing technology uses over 5,000 reference points to shape the lens geometry	Enhanced prescription accuracy across the lens. Sharper vision with a wider field of view.	✓	✓	✓	✓	✓
Variable Decentration	Allows variable placement of the lens design within the blank without the necessity of using a standard optical centre	Thinner lenses with a more balanced edge thickness	✓	✓	✓	✓	✓
Variable Corridor Lengths	The corridor length of the lens design can be adjusted to any size frame (min. fitting height of 14mm)	Wide frame choice no matter the shape or size	-	-	✓	✓	✓
Vision First Design™	The lens design incorporates binocular balance providing a balanced visual experience throughout the lens	Less soft focus areas for sharper, more natural vision	-	-	-	✓	✓
iSync™ Technology	Uses complex optical calculations incorporating ray tracing over the entire lens to correct oblique power errors that occur when viewing away from the optical centre	Constant superior vision over the entire lens with the widest viewing areas at the most important part of the lens	-	-	-	✓	✓
Adaptive Prescription	Includes 3 additional measurements for back vertex distance, pantoscopic tilt and face bow	Lenses compensate for frame choice and face shape offering the best possible vision correction	-	-	-	-	✓

DIGITAL FREEFORM

All KODAK Lens Digital Lenses benefit from digital freeform processing which provides optical improvement as well as being thinner and flatter in comparison to standard lenses. Digital freeform processing is achieved via a single point diamond tool precisely guided by a computer to allow three dimensional surfacing along x, y and z axis. As the lens spins, the diamond cutting tool tracks across the lens, providing a smooth finish.

BENEFITS

- Back surface design gives wider field of view
- Better image stability
- Significantly less distortion
- Sharp vision to lens edge
- Reduced magnification
- Match existing progressive corridors*
- Quicker adaptation
- Wider choice of frames

*Easy, Unique and Unique HD only.

A form of ray tracing, digital Surfacing Technology uses over 5000 points to determine the required geometry. This enhances the prescription accuracy across the lens.

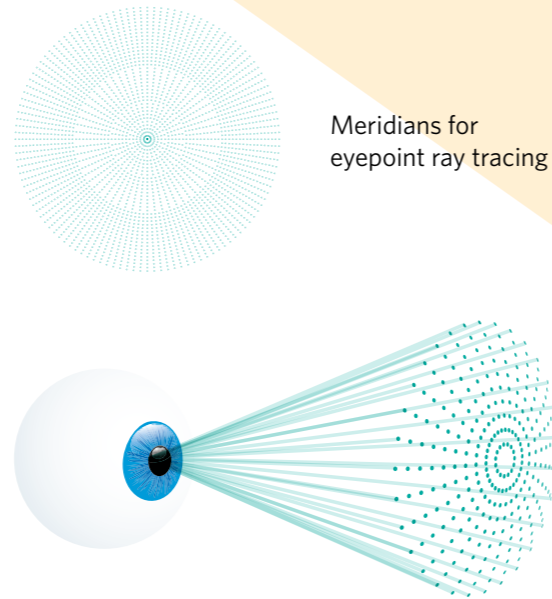

Meridians for eyepoint ray tracing

5000 points used to calculate geometry for typical wearing conditions = high precision

VARIABLE DECENTRATION

Variable Decentration allows the design of the lens to be repositioned within the blank which enables smaller lenses to be used. This in turn will produce a more balanced edge thickness nasally, temporally and at the top and bottom of the lens. Applies to all KODAK Lens Digital Lenses.

BENEFITS

- A more balanced substance at nasal, temporal, top and bottom
- Wider glazing frame choice
- Thinner lenses on plus powers

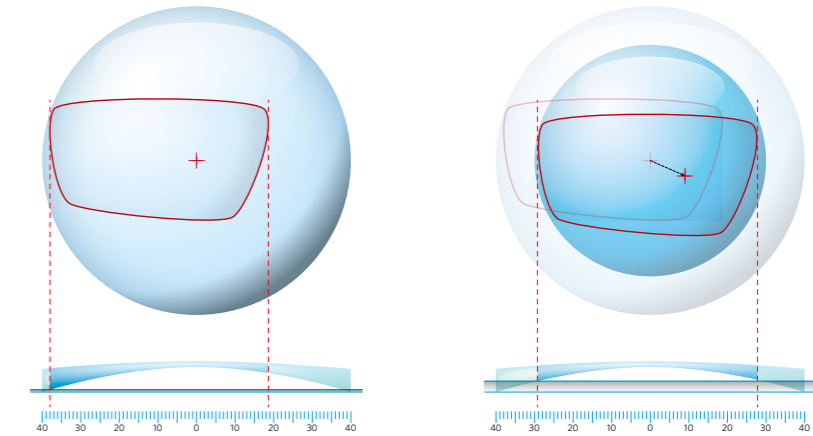

80mm Blank Conventional

60mm Blank Decentred

VARIABLE CORRIDOR LENGTH

Fashion often dictates the progressive lens choice. Applicable lenses are designed using key point referencing, allowing the same design principles to be applied to varying corridor lengths, thus making it a family of lenses that can be used for frames whatever their shape or size (from a minimum fitting height of only 14mm). The direct correlation in design between lenses with shorter and longer corridors results in excellent visual comfort regardless of frame choice.

SELF SELECT CORRIDOR LENGTHS

Products with variable corridor lengths are available to order in 2 ways:

- 1) Specifying frame measurements and prescription details, allowing complex software to select the most appropriate corridor length for your patient.
- 2) Specifying the preferred corridor length. By self selecting the corridor length, you are able to match the corridor length of your patient's existing progressive design in order to maintain similar head posture and eye rotation.

BENEFITS

- Wider frame choice for the patient
- Far easier adaptation when changing design

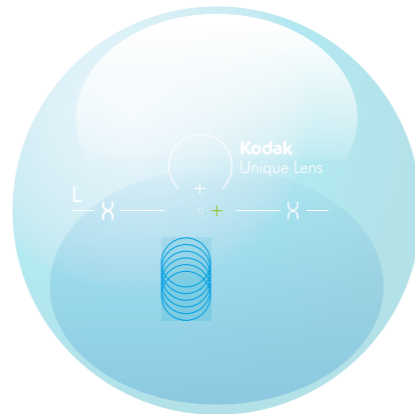

Corridor	Unique HD	Unique	Easy
13mm	✓	✓	✓
14mm	✓	✓	✓
15mm	✓	✓	
16mm	✓	✓	✓
17mm	✓	✓	
18mm	✓	✓	✓

VISION FIRST DESIGN™

Vision First Design™ provides a smooth mean power profile. As the eye travels across any horizontal area in the lower portion of the lens it will normally encounter many changes to mean power (diagram A). With Vision First Design™, the desired optical performance is specified, then the calculations needed to provide optimum results are calculated. This is opposite to how traditional progressive lenses are designed; firstly defining the geometry of the surface then analysing the optical performance. If the performance is not satisfactory the process is repeated.

Vision First Design™ allows the designer to incorporate binocular balance into the lens (diagram B). Providing a balanced visual experience throughout the lens.

BENEFITS

- Superior visual comfort
- Allows natural eye movement
- Provides sharper viewing in all directions
- Minimises blurring or 'swim effect'
- Faster adaptation speed and great patient satisfaction



DIAGRAM A
without Vision First Design™

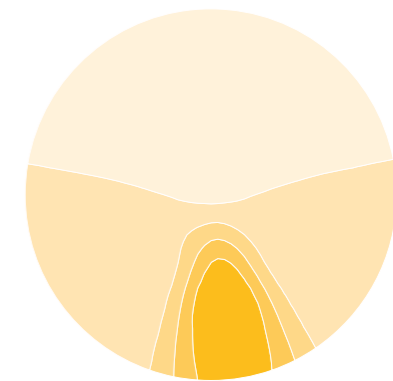

DIAGRAM B
with Vision First Design™

iSYNC™ TECHNOLOGY

iSync™ Technology uses precision optical and mathematical calculations within a complex software program. This program incorporates the results of ray tracing over the entire surface of the lens to correct oblique power errors that occur when viewing away from the optical centre.

Results of the final design enhance the visual experience by providing sharper, clearer and wider viewing areas. Each lens is designed for the right and left eye providing the widest viewing area at the most important part of the lens.

The table to the right demonstrates how iSync™ Technology effects the area of vision. As you can see, the unwanted astigmatism has disappeared from the distance area and the astigmatism free reading area has widened.

Power	Surface Analysis	What the patient will actually see	What the patient will see after the iSync™ Technology
+5.00			
+2.00			
-2.00			
-5.00			

BENEFITS

- More consistent optical performance over the range of prescription powers
- Wider viewing areas for Hyperopes
- Improved distance area for Myopes
- Improved image quality in principal viewing areas

ADAPTIVE PRESCRIPTION

Only available with KODAK Unique HD and Solartec Lenses

A premium technology found only on KODAK Unique HD and Solartec Lenses, Adaptive Prescription offers your patient a new level of customisation.

When glasses are being worn, the way a patients chosen frames sit on their face can dramatically alter the viewing experience through the prescribed powers.

With Adaptive Prescription the patient's Back Vertex Distance (BVD), pantoscopic tilt and face bow are calculated via a computer to create a compensated lens that has been optimised for that individual patient.

Depending on the frame position and prescription, Adaptive Prescription can dramatically improve the patient's viewing experience.

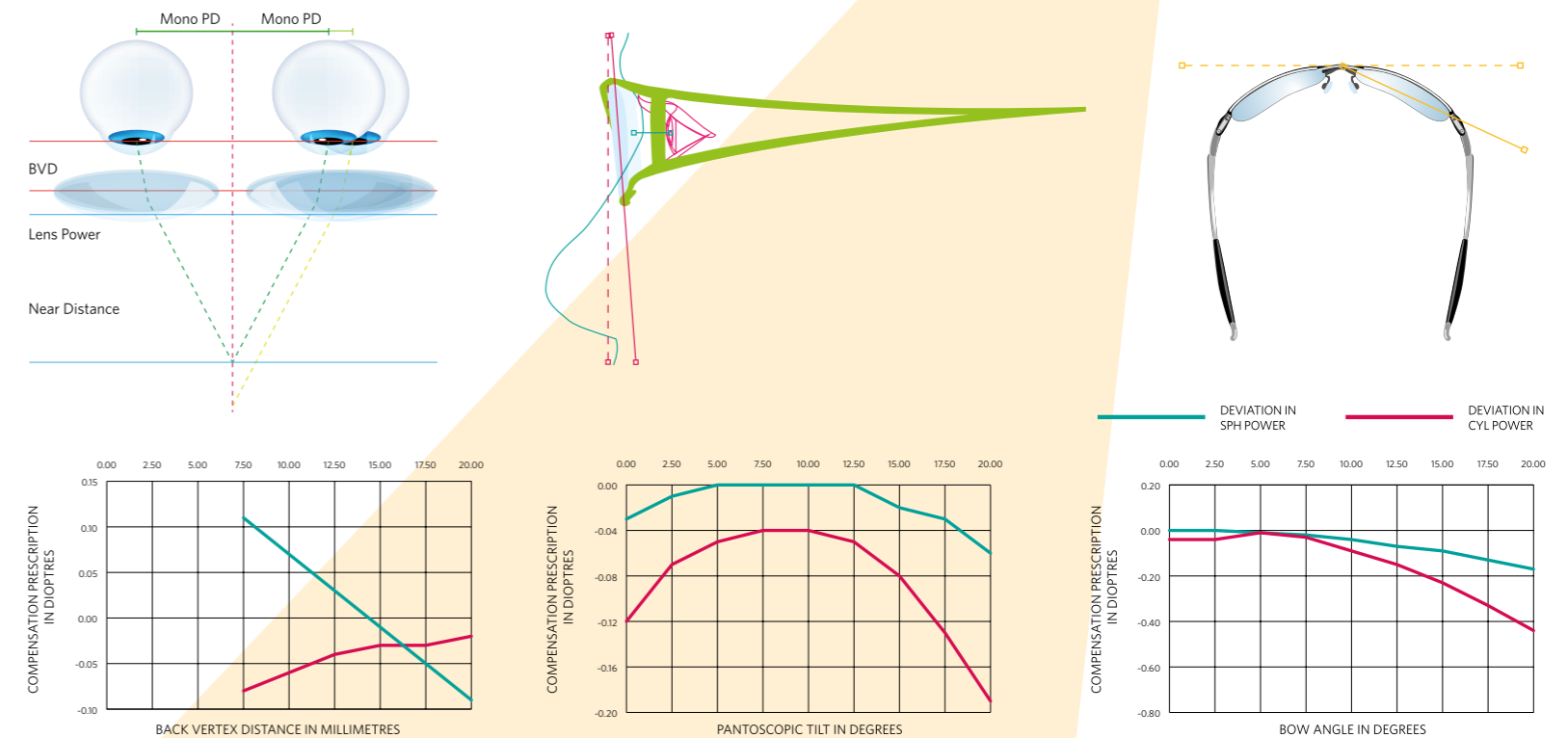

1. Definitions

In these conditions

"the Company" means Signet Armorlite Europe Limited
"the Customer" means the individual firm company or other party with whom the Company contracts.

"Supply" includes (but is not limited to) any supply under a contract of sale. For the purposes of these conditions a quotation shall include the listing of a product in the Company's current price list as varied by any authorised representative of the Company.

2. General

- Previous dealings between the Company and the Customer shall not vary or replace these terms or be deemed in any circumstances whatsoever so to do.
- No order in pursuance of any quotation or otherwise shall be binding on the Company unless and until such order is accepted by the Company either in writing (which shall include e-mail acknowledgement) or by despatch of the goods ordered. In the case of orders placed through the Company's website, the Customer accepts these conditions by submitting such order. Any contract made between the Company and the Customer (herein called "the Contract") shall be subject to these conditions and save as aforementioned no representative or agent of the Company has authority to agree any terms or make any representations inconsistent with them or to enter into any Contract except on the basis of them; any such terms representations or Contract will bind the Company only if in writing and signed by a director.
- Unless otherwise agreed in writing by the company these conditions shall override any terms and conditions stipulated or referred to by the Customer in his order or pre-contract negotiations.
- Any description contained in the Company's catalogues, samples, price lists or other advertising material is intended merely to present a general picture of the Company's products and shall not form a representation or be part of the Contract. All promotional material, price lists, catalogues and other documents prepared by the Company together with the "Presenter" provided for the Customer's use are and will at all times remain the property of the Company and without prejudice to the generality of the foregoing, no drawings or information therein may be copied or reproduced in whole or in part or divulged or transferred to a third party except in the promotion of the Company's products without the Company's written consent.
- In the event that the Company has not given a written acknowledgement of the Customer's order these conditions, provided the Customer shall have had prior notice of them, shall nonetheless apply to the Contract.
- The Company reserves the right to correct any clerical or typographical errors made by its employees at any time. Failure by the Company to enforce any of these conditions shall not be construed as a waiver of any of the Company's rights under the conditions of the Contract.

3. Design and Quality

- The goods supplied under a Contract shall correspond as much as possible with the Company's specification of the goods and shall be of merchantable quality but no warranty is given or shall be implied as to the suitability of the goods for any specific purpose.
- The Company reserves the right to make variations in the design and technical specification of the goods without imposing any obligation upon itself to incorporate such changes with products previously supplied.
- The Company does not nor will it assert or warrant the validity of any letters patent registered design or trade mark applying or applied to any goods supplied by the Company to the Customer under a Contract or that any dealing with any such goods is not or will not be an infringement of any patent design or trade mark rights of third parties.
- All goods will be made within reasonable manufacturing limits of dimensions. If special accuracy is required the Customer must state specifically in writing the maximum and minimum limits. The Company accepts no responsibility for the accuracy of information or drawings supplied by the Company.

4. Prices

- Subject to any agreement to the contrary the Company's quotations are provisional and may be altered to take account of any changes taking

place between the date of quotation and the Company's acceptance of the Customer's order in the price of the products to be supplied and other costs of sale (including any such increase arising from adverse movements in the rate of exchange between the £STG and the currency in which the supply to the Company by the relevant supplier is designated) or in the Customer's instructions or in the event that the Customer orders part only of the quantity referred to in any quotation.

- The Company shall be entitled to increase its prices at any time to take account of any increase in the cost to the Company of purchasing any goods or materials (including any such increase arising from adverse movements in the rate of exchange between the £STG and the currency in which the supply to the Company by the relevant supplier is designated)/ (including any such increase arising from any error or inadequacy in any instructions provided by the Customer) and such increased prices ruling at the date of despatch by the Company shall be substituted for the previous Contract price. All prices quoted are exclusive of VAT and the Customer shall pay any and all taxes duties and other government charges payable in respect of the goods.

5. Delivery

- Unless otherwise agreed in writing by the Company the Company agrees to deliver goods to the Customer which shall forthwith give to the Company all necessary instructions to enable such delivery to take place; the Company shall add to the Contract price of the goods a reasonable charge for packaging and delivery and off-loading shall be at the Customer's risk and expense.
- Subject to any agreement in writing by the Company, the risk in goods which the Company agrees to supply within the United Kingdom shall pass to the Customer on delivery or the date (if earlier) on which, the goods being ready for delivery, delivery is postponed at the Customer's request.
- Subject to any agreement in writing by the Company, the risk in goods which the Company agrees to supply outside the United Kingdom shall pass to the Customer in accordance with F.O.B. English Port as defined in Incoterms 1990.
- Should the Customer be unable to accept delivery of the goods at the time when the goods are available for delivery the Company may at its absolute discretion store the goods until actual delivery and the Customer shall be liable to the Company for the reasonable costs of storage handling and carriage. This provision shall be without prejudice to the Customer's liability in damages for failure to take delivery on the contractual date.
- The Company shall not be liable for any loss of or damage sustained by any goods left with the Company howsoever caused and whether or not attributable to negligence on the part of the Company or negligence or willful default on the part of any servant or agent of the Company.
- No claim for damage in transit shortage of delivery or loss of goods will be entertained by the Company unless (1) the Customer shall give to the Company written notice of such damage, shortage or loss either within such time as will enable the Company to comply with the carrier's conditions of carriage or three days, whichever is the shorter, and (2) where the goods have not been checked on acceptance from the carrier, the delivery book of the carrier has been signed "not examined".
- Should the Company be delayed in or prevented from making delivery of the goods due to war, governmental or parliamentary restrictions, strike, lock-outs, fire, floods, explosions, labour disturbances, trade disputes, damage to or destruction of the goods, breakdown of machinery, shortages of labour or of raw materials or Act of God or due to any other cause whatsoever beyond the reasonable control of the Company, the Company shall be at liberty to cancel or suspend the order placed by the Customer without incurring any liability for any loss or damage arising there-from.
- While the Company will endeavour to deliver the goods by any date or within any period agreed upon, such dates and periods are estimates only given in good faith and the Company will not be liable for any failure to deliver by such date or within such period. Moreover, the Company shall be entitled to defer delivery until any monies due from the Customer have been received.
- The Company may deliver the goods in instalments unless otherwise agreed. When delivery by instalments is specified each delivery shall for the purpose of this sub-clause only be deemed to constitute a separate contract and the failure of any one or more deliveries shall not be deemed to be a repudiation of the Contract.

- Save as provided by paragraph 7 hereof the Customer shall not be entitled to return goods or refuse to accept delivery without the Company's prior written consent.

6. Payment Terms

- For the purpose of this paragraph the goods shall mean the whole or any instalment of the goods which the Company has agreed to supply and the relevant date shall be the date on which
 - the Company despatches the goods or
 - the Customer defaults in its obligations under sub-paragraph (b) hereof whichever shall first occur.
- Unless otherwise specified in writing by the Company payment shall be made by the Customer net cash not later than 25 days from the statement date. Time for payment shall be of the essence of the contract. Without prejudice to any other rights of the Company interest will be payable on all overdue accounts at 2% per month and the Company shall be entitled to recover all other costs or expenses incurred and for the purpose of paragraphs 7 and 9 hereof the full purchase price of the goods shall include delivery and packaging charges together with any interest payable and costs hereunder. In the case where overdue balances occur we will add collection costs. The Customer shall not be entitled to withhold or set off payment of any amount payable to the Company under this or any other Contract by reason of any dispute which it may have with the Company.
- Without prejudice to any other terms herein if payments to the Company on any account are delayed beyond the due date for payment or if the Customer shall enter into any composition or any arrangement with his creditors or if the Customer being a corporation shall have an administrative receiver or administrator appointed or shall pass a resolution for winding-up or a Court shall make an order to that effect or if there shall be breach of any of the terms and conditions hereof the Company shall be entitled to withdraw credit facilities from the Customer.

7. Cancellation

- If the Customer shall fail to make any payment when it becomes due or shall enter into any composition or any arrangement with his creditors or if being a corporation shall enter into a corporate voluntary arrangement or have an administrative receiver or administrator appointed or shall pass a resolution for winding up or a Court shall make an order to that effect or if there shall be any breach by the Customer of any of the terms and conditions hereof the Company may defer or cancel any further deliveries and treat the Contract of which these conditions form part as determine but without prejudice to its rights to the full purchase price for goods delivered and damages for any loss suffered in consequence of such determination.
- Cancellation by the Customer will only be accepted at the discretion of the Company and in any case on condition that any costs or expenses incurred by the Company up to the date of cancellation and all loss or damage resulting to the Company by reason of such cancellation will be paid by the Customer to the Company forthwith. Acceptance of such cancellation will only be binding on the Company if in writing.

8. Warranty

- Save as otherwise provided in these conditions and with the exception of goods supplied with specific warranty the Company's liability in respect of any defect in or failure of goods supplied is limited to replacing or repairing or paying for the repair or replacement of goods which within a reasonable period after delivery to the Customer are proved to be defective by reason of faulty or incorrect workmanship or materials PROVIDED that the Company's liability (if any) in respect of any direct loss or damage sustained by the Customer as a result of such defect shall not exceed the price of the goods. Conditions precedent to the Company's liability (if any) hereunder shall be that
 - the goods shall have been subject to reasonable and proper use by the user thereof whether or not the Customer shall be able to control such use (or misuse);
 - the Customer shall have given to the Company reasonable notice of the defect as soon as reasonably practicable;
 - as soon as reasonably practicable the Customer shall have either returned the goods to the Company or provided authority for the Company's servants or agents to inspect them, as the Company may request. The Company shall have no other or further liability in respect of any direct or consequential loss or damage sustained by the Customer arising from or in connection with any such defect.
- All goods sold by the Company are supplied with terms implied by Section 12 of the Sale of Goods Act 1979 and where the Customer is not dealing or holding himself out as dealing in the course of a business sections 13, 14 and 15 thereof. Subject to the Company providing a warranty in the Terms of that provided by the manufacturer and whether or not the Contract is a contract of sale, all other conditions, warranties and other terms express or implied, statutory or otherwise, are expressly excluded, save insofar as contained herein or as otherwise expressly agreed by the Company in writing PROVIDED that if and insofar as any legislation or any order made thereunder shall make or have made it unlawful to exclude or purport to exclude from the Contract any term or shall have made unenforceable any attempt to exclude any such term, the foregoing provisions of this paragraph will not apply to any such term.
- Save as hereinbefore provided and subject to the provision of Section 2(l) of Unfair Contract Terms Act 1977 the Company shall not be liable to the Customer for any damage or for any direct or consequential loss incurred by the Customer in consequence of any negligence on the part of its servants or agents in or in connection with the supply of any goods.

9. Title

- The following provisions shall apply to all Contracts. No failure by the Company to endorse strict compliance by the Customer with such provisions shall constitute a waiver thereof and no termination of the Contract shall prejudice limit or extinguish the Company's rights under this paragraph. Payment shall mean payment in cash such that the Company's acceptance of a cheque shall constitute conditional payment only until such cheque has been cleared and cash received.
 - Upon delivery of the goods the Customer shall hold the goods solely as bailee for the Company and the goods shall remain the property of the Company until such time as the Customer shall have paid to the Company the full purchase price of all goods supplied under the Contract or any other contract. Until such time the Company shall be entitled to recover the goods or any part thereof and for the purpose of exercising such rights the Company, its employees and agents with appropriate transport may enter upon the Customer's premises and any other location where the goods are situated.
 - Before payment in full is made the Customer shall have power to resell the goods as principal towards the sub-customer, but as agent and fiduciary between the Customer and the Company, the proceeds of sale thereby arising belonging accordingly to the Company.
 - The Customer shall maintain all appropriate insurance in respect of the goods from the date or dates on which the risk therein passes to it. In the event of any loss or damage occurring while the goods remain the property of the Company the Customer shall immediately on receipt of the insurance monies, remit to the Company the full purchase price of the goods lost or damaged less any part thereof which has already been paid and until such amount has been so remitted shall hold such amount as trustee and agent for the Company.
 - The licence granted under sub-paragraph (ii) above shall be terminable forthwith at any time upon notice by the Company to the Customer and in any event shall terminate automatically upon the happening of any of the following:-
 - if payments to the Company on any account are delayed beyond the due date for payment;

- if any cheque promissory note bill of exchange or any other negotiable instrument tendered by the Customer shall be dishonoured on first presentation; or
- if the Customer shall enter into any composition or any arrangement with his creditors or if the Customer being a corporation shall have an administrative receiver or administrator appointed or shall pass a resolution for winding-up or a Court shall make an order to that effect or if there shall be breach of any of the terms and conditions hereof.

10. Lien

The Company shall have a general lien over all goods and property of the Customer (whether worked on or not) in the possession of the Company for all unpaid debts due from the Customer and the Company reserves the right upon the expiration of fourteen days notice to dispose of such goods or property and to apply the proceeds of sale (net of costs of sale) towards the payment of such debts.

11. Exports

- In respect of sales of goods outside the United Kingdom ("Export Sales") the provisions of these conditions shall apply unless inconsistent with the terms of this clause.
- Unless otherwise specifically agreed between the Company and the Customer all Export Sales shall be made:-
 - In the case of existing customers, C.I.F. to the Customers premises and the Company's prices shall be increased to cover the Company's costs in making such deliveries and
 - In the case of new customers, F.O.B. UK Port of Loading.
- Unless otherwise agreed in writing, payment for Export Sales shall be by Confirmed Irrevocable Letter of Credit ("CILC") issued by a United Kingdom Bank. Such CILC shall allow for transshipment, partial shipment and shall be transferable by the Company.
- The Customer warrants that if an import licence or permit is required for the importation of the goods into the country of destination then such import licence or permit has been obtained or will be obtained prior to shipment.

12. Data Protection Act 1998

- The Customer consents under the Data Protection Act 1998 to the processing of its personal data for the purpose of the Company's business and associated activities, and the passing of this data to credit reference agencies, banks, credit insurers and other responsible organisations.

13. Jurisdiction

- The proper law of all Contracts with the Company shall be English Law which shall govern in all respects the construction and effect of such Contracts and of these conditions. The Customer agrees that in the event of any dispute arising out of the Contract or the performance thereof it will submit to the exclusive jurisdiction of the English Courts.
- These conditions shall not affect the statutory rights of a consumer and nothing in these conditions shall exclude or restrict any liability that the Company may have by virtue of the Consumer Protection Act 1987.

Terms of Acceptance

In placing an order with this company the customer confirms he has verified the mutual compatibility of customer supplied medical device(s) in accordance with the manufacturer's instructions.

Cancellation or Alteration

The customer will be charged for all work carried out up to the time the order is cancelled or altered.

Queries

Any job returned for query must be accompanied by the original order.

Prices

All prices are pounds sterling and per single lens, unless stated otherwise, and are subject to P&P and VAT.
 All orders are accepted subject to prices ruling at the date of despatch.
 Where the use of stock lenses will not produce a satisfactory job due to the frame shape, design and/or lens prescription, surfaced lenses will be supplied at the appropriate additional charge.
 Lens products not shown are charged at nett plus VAT.

Ordering

To assist processing, customers are recommended to use our order forms available on request.

Unless RX orders specify to the contrary, we will ensure correct horizontal centration by supplying large lenses and/or prisms where necessary. In cases where nearest centration is acceptable, this must be stated clearly on the order, along with the blank size to be used.

Orders for half pairs should be sent with the other lens, so that its form can be matched. Orders for half pairs to be prepared must state form required, including height of optical centre above segment on bifocals.

Balance Lenses

When providing requests for balanced lenses, our policy is to:

- Match lens type
- Surface where necessary.
- Match best power.

Terms Of Trading

Payment to be made not later than 25 days from statement date. Immediate credit available.

Payment Methods

Cheques should be made payable to: Signet Armorlite Europe Ltd.

Promotional Material

Promotional material (for example, posters and point of sale materials) supplied by Signet Armorlite Europe may not be altered in any way. Users of such promotional materials are authorised to insert details of the sales outlet into the appropriate section in such promotional material but are not otherwise entitled to place any additional statements or trademarks.

Promotional material supplied by Signet Armorlite Europe must be used exclusively for the sale of products manufactured or supplied by Signet Armorlite Europe.

Any promotional material supplied by Signet Armorlite Europe must be kept in good condition and only used in the United Kingdom.

Signet Armorlite Europe shall be entitled to repossess at any time any promotional material supplied by us.

Images can not be used or reproduced without prior written authorisation from Signet Armorlite. Copyright and license infringement may result as a direct consequence.

90 Day Progressive Warranty

At Signet Armorlite we offer a 90 day non-tolerance guarantee whereby we will issue a credit voucher to the monetary value of your original order. The credit voucher is valid for 12 months and can be redeemed against any of our progressive lenses. If the cost of the new order is greater you will only be charged for the difference. The 90 day guarantee is effective from the date the lenses were despatched from Signet Armorlite, and is subject to all our fitting criteria and recommendations. Signet Armorlite reserves the right to refuse credit if they believe any of the conditions have not been adhered to.

The warranty only covers genuine intolerance by the patient and does not cover prescribing or dispensing errors, changes to prescriptions, duplication or damage to lenses.



Signet Armorlite Europe

1-7 Apollo, Olympus Park
Quedgeley, Gloucester, GL2 4NF
T: 01452 720 201
F: 01452 720 004
www.saeurope.co.uk

HOW TO ORDER

CALL 01452 887 400

EMAIL orders@kodaklens.co.uk

FAX 01452 720 004

ONLINE www.saeurope.co.uk

OR CONTACT YOUR KODAK LENS REGIONAL MANAGER



The KODAK trademark and trade dress are used under license from KODAK by Signet Armorlite, Inc. ©2016. Transitions and the swirl are registered trademarks of Transitions Optical, Inc., used under license by Transitions Optical Limited. ©2016 Transitions Optical Limited. All trademarks and registered trademarks are property of registered users.

Kodak LENS

DIGITAL PROGRESSIVE LENSES

AGE-DEFYING LENSES FOR CLEAR
VISION AT ANY DISTANCE



KODAK CONCISE LENSES

The KODAK Concise Digital Lens is an entry level progressive lens that has been designed for shallower frames.

Although these lenses are designed to fit into a shallow frame they still provide a maximum reading area to promote natural eye movement. The lenses are digitally produced for a wider field of view with better image stability and less distortion.

WEARER BENEFITS

- Wide near zone for natural eye movement
- Smooth graduation of power
- Optimised for shallower frames
- Suitable for almost all frame choices to suit any desired style or look
- Thinner and lighter with the visual appearance of a single vision lens
- Digitally produced for a wider field of view with better image stability and less distortion



LENS TECHNOLOGY

- Digital Freeform ✓
- Variable Decentration ✓
- Variable Corridor Length ✗
- Vision First Design™ ✗
- iSync™ ✗
- Adaptive Prescription ✗

See guide book for more details

KODAK LENS FINISHES



Clear



Clean&Clear



Clean&Clear UV



BluProtect

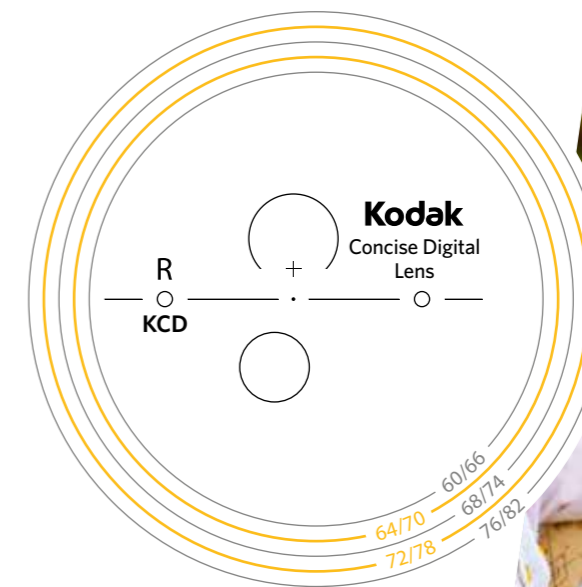
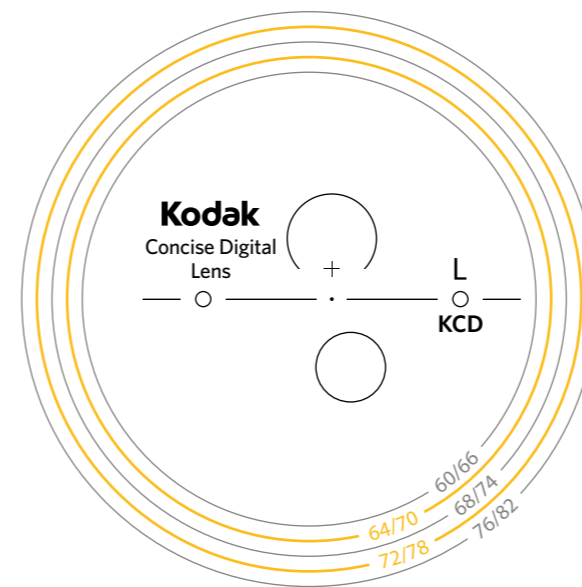

Range	Clear	Polarised	Photoviews	Transitions® Signature™ VII	Transitions® XTRActive™
1.50	✓	✓	✓	✓	✓
1.53	✓			✓	
1.59					
1.60	✓		✓	✓	✓
1.67	✓			✓	✓
1.74	✓				

Minimum Fitting Height	14mm
Corridor Length	13mm
Minimum Distance to Top Rim	9mm
Fitting Cross above Prism Reference Point	4mm
Decentred	3mm/ Variable

Full range information available in the KODAK Lens Range Chart booklet.



KODAK PRECISE LENSES

The KODAK Precise Digital Lens is an entry level progressive lens. The lens features a wide near zone for natural eye movement with ultra-smooth, tightly controlled power progression throughout all zones. This offers wearers a clear visual experience even in the lens periphery.

WEARER BENEFITS

- Wide near zone for natural eye movement
- Smooth graduation of power
- Suitable for almost all frame choices to suit any desired style or look
- Thinner and lighter with the visual appearance of a single vision lens
- Digitally produced for a wider field of view with better image stability and less distortion



LENS TECHNOLOGY

- Digital Freeform ✓
- Variable Decentration ✓
- Variable Corridor Length ✗
- Vision First Design™ ✓
- iSync™ ✗
- Adaptive Prescription ✗

See guide book for more details

KODAK LENS FINISHES



Clear



Clean&Clear



Clean&Clear UV



BluProtect

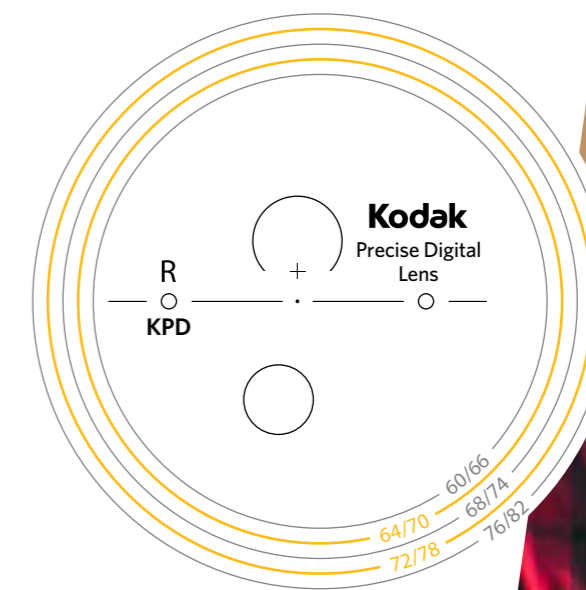
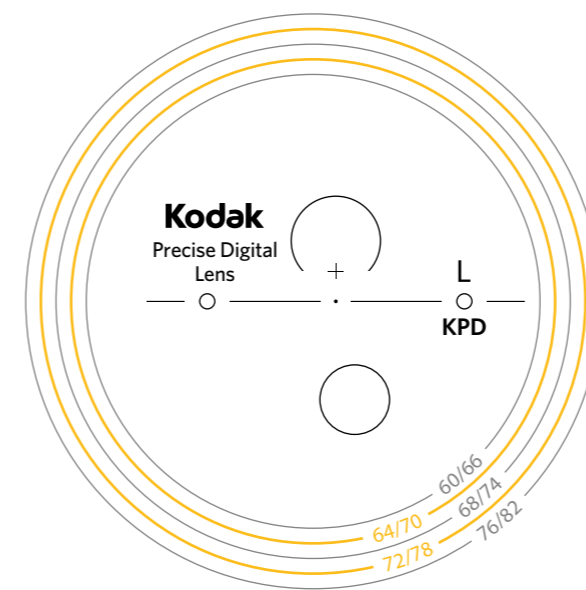

Range	Clear	Polarised	Photoviews	Transitions® Signature™ VII	Transitions® XTRActive™
1.50	✓	✓	✓	✓	✓
1.53	✓			✓	
1.59					
1.60	✓		✓	✓	✓
1.67	✓			✓	✓
1.74	✓				

Minimum Fitting Height	18mm
Corridor Length	17mm
Minimum Distance to Top Rim	9mm
Fitting Cross above Prism Reference Point	4mm
Decentred	3mm/ Variable

Full range information available in the KODAK Lens Range Chart booklet.



KODAK EASY LENSES

A KODAK Easy Lens is a digital lens that's ideal for first time progressive wearers due to softer transition between the powers. The lens provides patients with a clear field of vision right to the lens edge and is designed to deliver a natural head and eye movement experience where the requirement for a wider reading and intermediate area is preferred.

This lens is simple to dispense due to the variable corridor lengths. The digital freeform production process also provides a wider field of view with better image stability and less distortion.

WEARER BENEFITS

- Slightly softer transition between powers ideal for first time progressive wearers
- A wider reading and intermediate area promotes natural head and eye movement
- Suitable for almost all frame choices to suit any desired style or look
- Thinner and lighter with the appearance of a single vision lens
- Digitally produced for a wider field of view with better image stability and less distortion



LENS TECHNOLOGY

- Digital Freeform ✓
- Variable Decentration ✓
- Variable Corridor Length ✓
- Vision First Design™ *✓
- iSync™ ✗
- Adaptive Prescription ✗

See guide book for more details

* Available April 2016

KODAK LENS FINISHES



Clear



Clean&Clear



Clean&Clear UV



BluProtect

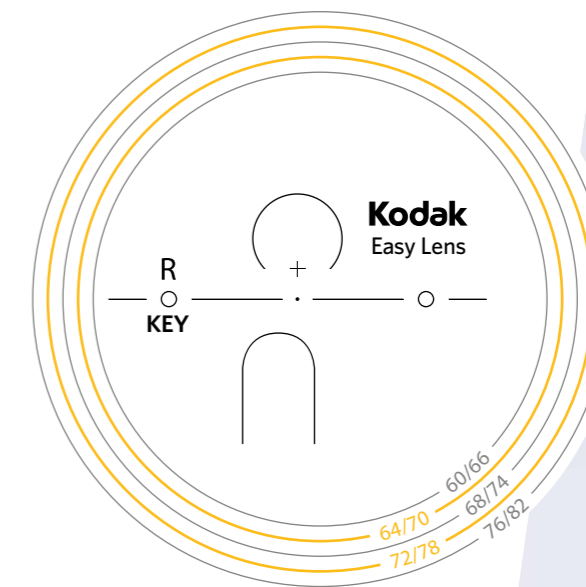
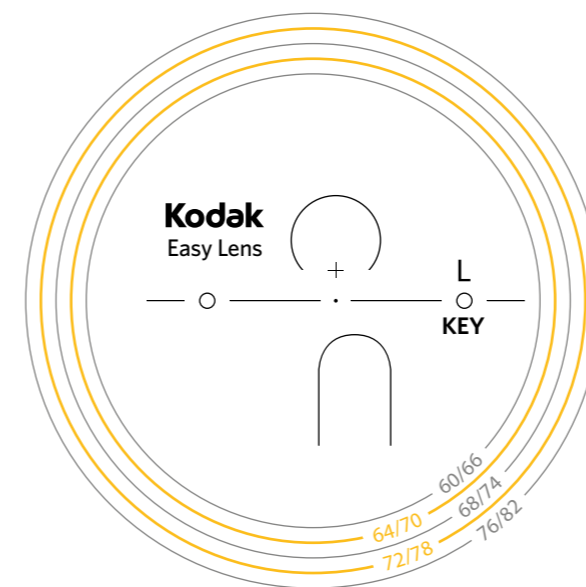

Range	Clear	Polarised	Photoviews	Transitions® Signature™ VII	Transitions® XTRActive™
1.50	✓	✓	✓	✓	✓
1.53	✓			✓	
1.59					
1.60	✓		✓	✓	✓
1.67	✓			✓	✓
1.74	✓				

Minimum Fitting Height	14mm
Corridor Length (mm)	13, 14, 16, 18 or auto select
Minimum Distance to Top Rim	9mm
Fitting Cross above Prism Reference Point	4mm
Decentred	3mm/ Variable

Full range information available in the KODAK Lens Range Chart booklet.



KODAK UNIQUE LENSES

The KODAK Unique Lens is a premium progressive lens that features sharper transition between the powers, this offers better performing vision when moving between distances. The lens also benefits from Vision First and iSync™ Technology (see introduction booklet) as well as a digital freeform production process that allows a wider field of view with better image stability and less distortion.

This lens will provide patients with an excellent field of vision right to the very edge of the lens and are easy to dispense due to variable corridor lengths and a minimum fitting height of just 14mm. Offering patients these lenses will ensure they receive premium lenses with the most advanced design technology.

WEARER BENEFITS

- Sharper transition between lens powers
- Clearer vision across the lens with less blurring or “swim” effect
- Suitable for almost all frame choices to suit any desired style or look
- Thinner and lighter with the visual appearance of a single vision lens
- An advanced progressive from a premium brand
- Digitally produced for a wider field of view with better image stability and less distortion



LENS TECHNOLOGY

- Digital Freeform ✓
- Variable Decentration ✓
- Variable Corridor Length ✓
- Vision First Design™ ✓
- iSync™ ✓
- Adaptive Prescription ✗

See guide book for more details

KODAK LENS FINISHES



Clear



Clean&Clear



Clean&Clear UV



BluProtect

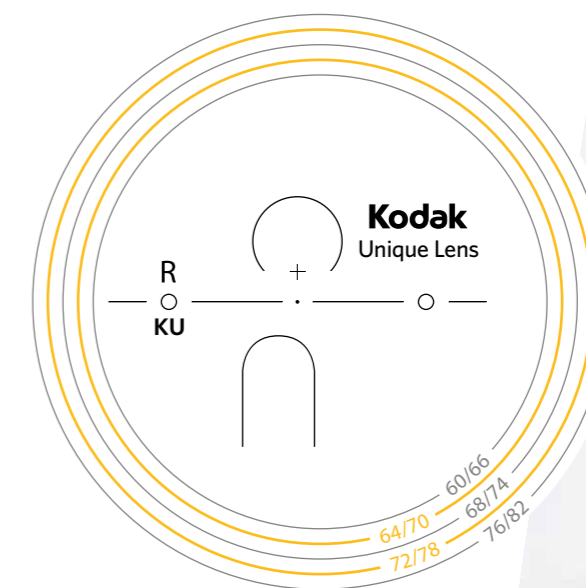
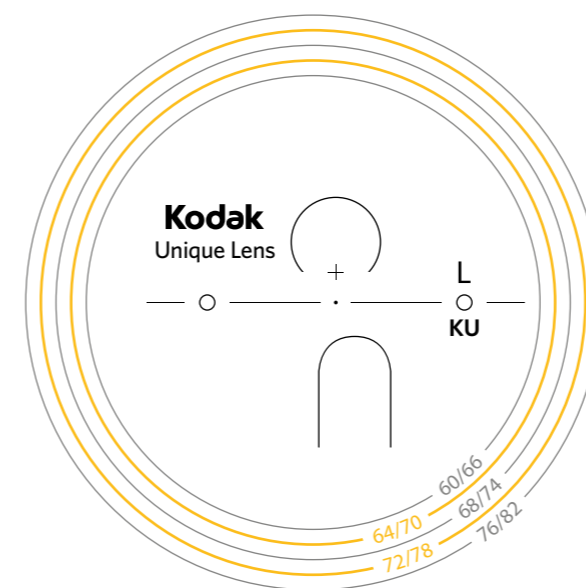

Range	Clear	Polarised	Photoviews	Transitions® Signature™ VII	Transitions® XTRActive™
1.50	✓	✓	✓	✓	✓
1.53	✓			✓	
1.59	✓				
1.60	✓	✓	✓	✓	✓
1.67	✓	✓		✓	✓
1.74	✓			✓*	

*Grey and Brown Only.
Full range information available in the KODAK Lens Range Chart booklet.

Minimum Fitting Height	14mm
Corridor Length (mm)	13, 14, 15, 16, 17, 18 or auto select
Minimum Distance to Top Rim	9mm
Fitting Cross above Prism Reference Point	4mm
Decentred	3mm/ Variable



KODAK UNIQUE HD LENSES

The KODAK Unique HD Lens is the culmination of the most advanced lens technologies and wearer benefits available. This premium lens introduces a new level of customisation to the KODAK Unique Lens design with the inclusion of Prescription Compensation and Variable Reading Area Inset.

Offer your patients unrivalled precision for their prescription with the Prescription Compensation of these lenses, supply us with the 3 trigger point measurements for pantoscopic angle, face form angle and the back vertex distance and our unique algorithms will calculate the perfect pair of lenses to match the patient's frame choice and facial features.

The KODAK Unique HD Lens is easy to dispense due to variable corridor lengths and a minimum fitting height of just 14mm. The extra measurements can be taken with a free KODAK Lens PD rule or via KODAK Lens' Intelligent Dispensing Software for the iPad.

WEARER BENEFITS

- Lens design considers frame choice and face shape offering the best possible vision correction
- Sharper transition between lens powers
- Clearer vision across the lens with less blurring or "swim" effect
- Thinner and lighter with the visual appearance of a single vision lens
- KODAK Lens' most advanced progressive lens
- Digitally produced for a wider field of view with better image stability and less distortion



LENS TECHNOLOGY

- ✓ Digital Freeform
- ✓ Variable Decentration
- ✓ Variable Corridor Length
- ✓ Vision First Design™
- ✓ iSync™
- ✓ Adaptive Prescription

See guide book for more details

KODAK LENS FINISHES



Clear



Clean&Clear



Clean&Clear UV



BluProtect

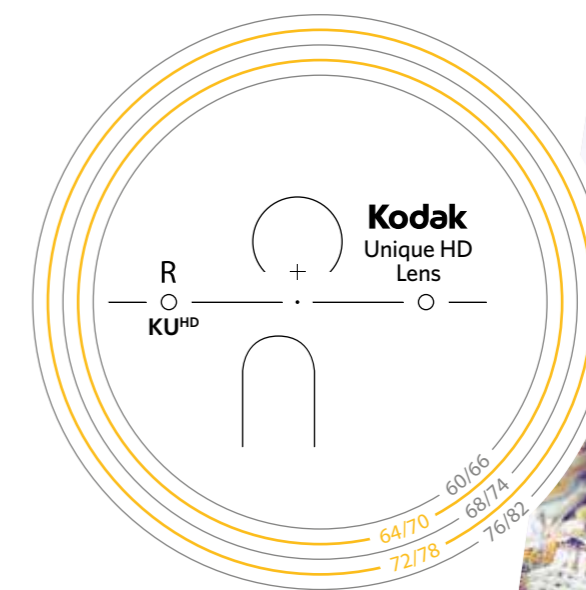
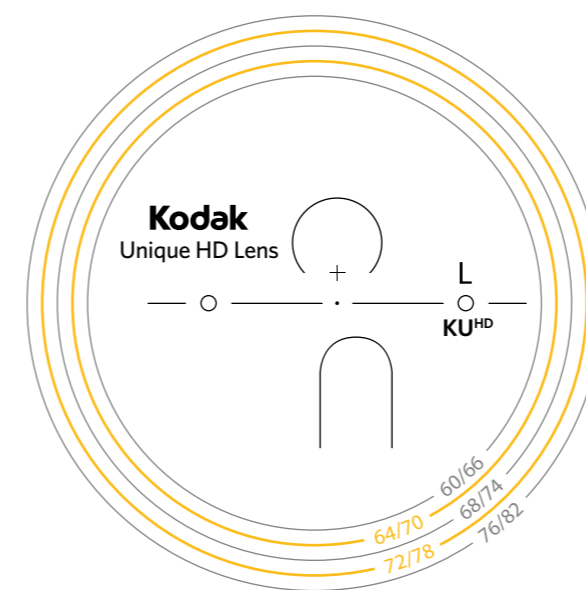

Range	Clear	Polarised	Photoviews	Transitions® Signature™ VII	Transitions® XTRActive™
1.50	✓	✓	✓	✓	✓
1.53	✓			✓	
1.59	✓				
1.60	✓	✓	✓	✓	✓
1.67	✓	✓		✓	✓
1.74	✓			✓*	

*Grey and Brown Only.
Full range information available in the KODAK Lens Range Chart booklet.

Minimum Fitting Height	14mm
Corridor Length (mm)	13, 14, 15, 16, 17, 18 or auto select
Minimum Distance to Top Rim	9mm
Fitting Cross above Prism Reference Point	4mm
Decentred	3mm/ Variable





Signet Armorlite Europe

1-7 Apollo, Olympus Park
Quedgeley, Gloucester, GL2 4NF
T: 01452 720 201
F: 01452 720 004
www.saeurope.co.uk

HOW TO ORDER

CALL 01452 887 400

EMAIL orders@kodaklens.co.uk

FAX 01452 720 004

ONLINE www.saeurope.co.uk

OR CONTACT YOUR KODAK LENS REGIONAL MANAGER



The KODAK trademark and trade dress are used under license from KODAK by Signet Armorlite, Inc. ©2016. Transitions and the swirl are registered trademarks of Transitions Optical, Inc., used under license by Transitions Optical Limited. ©2016 Transitions Optical Limited. All trademarks and registered trademarks are property of registered users.

Kodak LENS

An overhead, top-down view of a group of people sitting around a rustic wooden table. The scene is brightly lit, suggesting an indoor office or cafe environment. In the center, there are several coffee cups, a small potted basil plant, and a pair of glasses. On the right side, a silver laptop is open, with a person's hands visible on the keyboard. The background shows the heads and shoulders of several people, some looking towards the center of the table. The overall atmosphere is one of collaborative work and casual interaction.

OFFICE, HOBBY AND SPORTS LENSES

THE VISION TO WORK HARD
AND PLAY HARDER

KODAK SOFTWEAR LENSES

A KODAK SoftWear Lens is an occupational progressive designed to relieve the symptoms of eye strain commonly experienced in an office environment. The lens features extra wide areas for indoor visual needs, optimising the range of viewing distances typically used by people who spend significant periods working with computers or at a desk. The central zone of the lens has an intermediate add correction for viewing computer monitors and a near zone correction for reading.

Combine a KODAK SoftWear Lens with a KODAK BluProtect Lens finish to offer your patients a powerful occupational solution that provides clear, reflection free vision, minimises eye strain and protects the patient's eyes and sleep cycles from harmful blue light. If your patient is a red-eyed office worker who has trouble switching off at bedtime, look no further.

WEARER BENEFITS

- Clear, optimal vision when working in an office environment
- Reduced eye strain at the end of a working day
- Perfect for clearly seeing a keyboard, computer screen or nearby colleague
- Perfect solution for occupations and hobbies that require a lot of near and intermediate vision
- Thinner and lighter with the visual appearance of a single vision lens
- Digitally produced for a wider field of view with better image stability and less distortion



LENS TECHNOLOGY

- Digital Freeform ✓
- Variable Decentration ✗
- Variable Corridor Length ✗
- Vision First Design™ ✗
- iSync™ ✗
- Adaptive Prescription ✗

See guide book for more details

KODAK LENS FINISHES



Clear



Clean&Clear



Clean&Clear UV



BluProtect

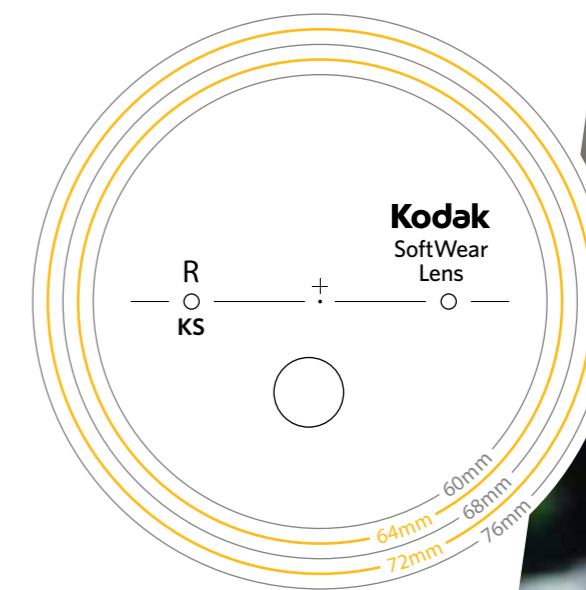
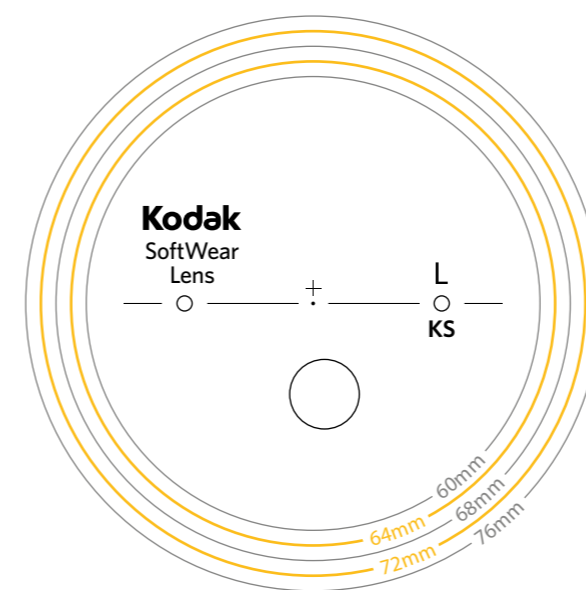

Range	Clear	Polarised	Photoviews	Transitions® Signature™ VII	Transitions® XTRActive™
1.50	✓				
1.53					
1.59					
1.60	✓				
1.67	✓				
1.74					

Full range information available in the KODAK Lens Range Chart booklet.

Minimum Fitting Height	17mm
Corridor Length	14mm
Minimum Distance to Top Rim	9mm
Fitting Cross above Prism Reference Point	2mm
Decentred	0mm

ORDERING INFORMATION

- Distance and add power
- Monocular pupillary distance
- Monocular fitting height to pupil centre
- Patient's computer monitor viewing distance (450 to 760 mm)
- Frame details

Inform the patient that the lenses are NOT to be used when driving or performing tasks that require clear distance vision.

KODAK ANTI-FATIGUE LENSES

People will invest a lot of time and energy into a something they love, with most hobbies involving repetitive tasks at a fixed distance that take a heavy toll on the eyes. This can include painting, gardening, watching TV or anything involving a computer such as gaming or online shopping. A KODAK Anti-Fatigue Lens is an enhanced single vision lens designed to reduce the symptoms of eye strain and tired eyes.

The design incorporates a small additional power (0.66DS or 1.00DS) within the lens for visual support when completing near or intermediate task. Think of this small extra power as a helpful 'pillow' for single vision patients to rest their tired eyes upon, this means the lenses are ideal for pre-presbyopes.

WEARER BENEFITS

- Provides relief and support for repetitive tasks at a near or intermediate distance
- Reduces eye muscle fatigue
- Suitable for everyday wear
- Thinner and lighter with the visual appearance of a single vision lens
- Digitally produced for a wider field of view with better image stability and less distortion



LENS TECHNOLOGY

- Digital Freeform ✓
- Variable Decentration ✗
- Variable Corridor Length ✗
- Vision First Design™ ✗
- iSync™ ✗
- Adaptive Prescription ✗

See guide book for more details

KODAK LENS FINISHES



Clear



Clean&Clear



Clean&Clear UV



BluProtect

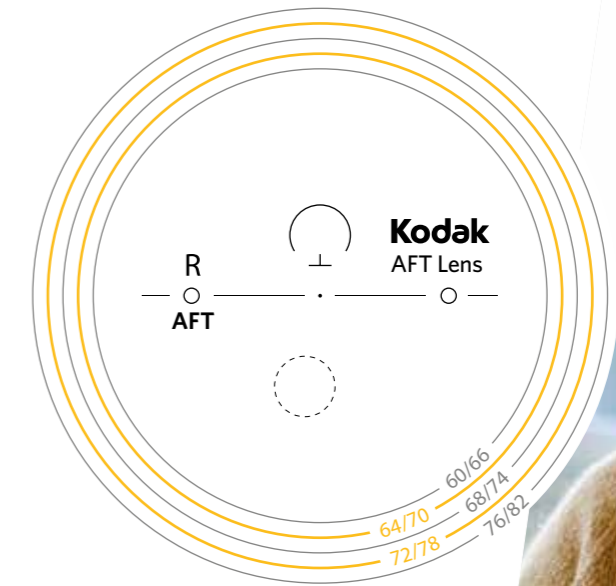
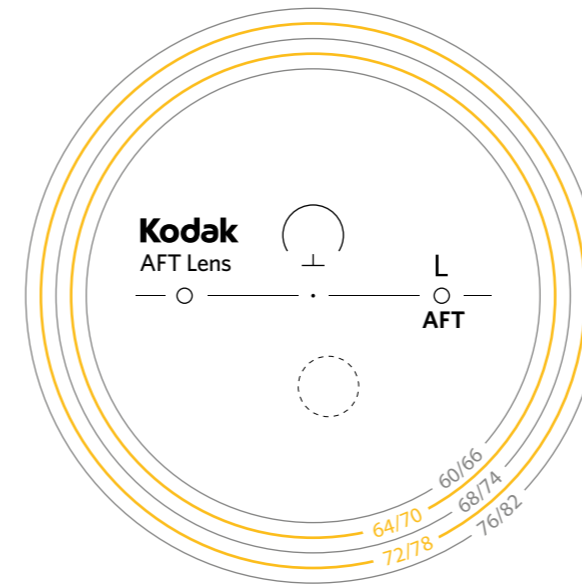

Range	Clear	Polarised	Photoviews	Transitions® Signature™ VII	Transitions® XTRActive™
1.50	✓			✓	
1.53	✓			✓	
1.59	✓				
1.60	✓			✓	
1.67	✓			✓	
1.74	✓				

Full range information available in the KODAK Lens Range Chart booklet.

Minimum Fitting Height	15mm
Corridor Length	14mm
Minimum Distance to Top Rim	9mm
Fitting Cross above Prism Reference Point	4mm
Decentred	3mm

ORDERING INFORMATION

- Distance and add power
- Monocular pupillary distance
- Monocular fitting height to pupil centre
- 0.66 or 1.00 add.



KODAK SOLARTEC LENSES

KODAK Digital SolarTec Lenses have been specifically designed to overcome the challenges of wraparound frames.

Lenses for a wraparound frame require specialist manufacturing to incorporate a high base curve into a prescription lens. Combining the individual fitting parameters of your patient with a highly curved frame can result in new powers for sphere, cylinder and axis, a compensation of prism and modified centring data.

With a KODAK Digital SolarTec Lens, the prescription data is specifically calculated for the individual lens position in front of the wearer's eye, eliminating problems associated with conventional lenses in wraparound frames. This ensures an easy dispense for you and a great result for the patient.

KODAK Digital SolarTec Lenses are available as single vision or varifocal and can be combined with other enhancements such as KODAK UVSun Polarised or Transitions®.

WEARER BENEFITS

- Clear vision through the lens
- Panoramic field of vision
- UV light protection (level depends on material and coating choice)



LENS TECHNOLOGY

- Digital Freeform ✓
- Variable Decentration ✗
- Variable Corridor Length ✗
- Vision First Design™ ✗
- iSync™ ✗
- Adaptive Prescription ✓

See guide book for more details

KODAK LENS FINISHES



Clear



Clean&Clear



Clean&Clear UV



BluProtect

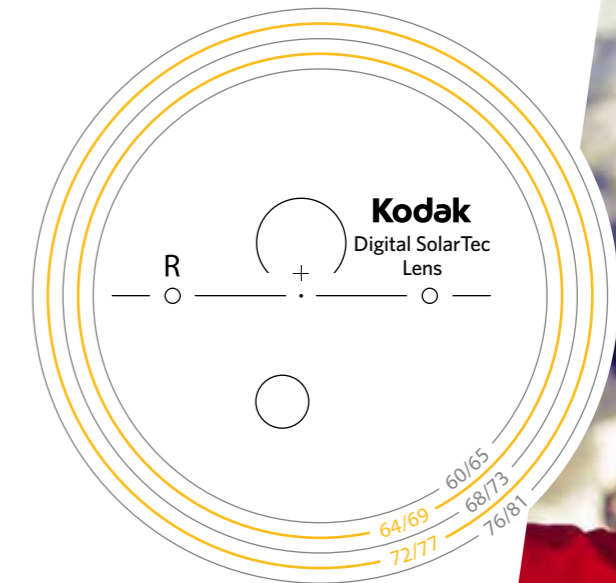
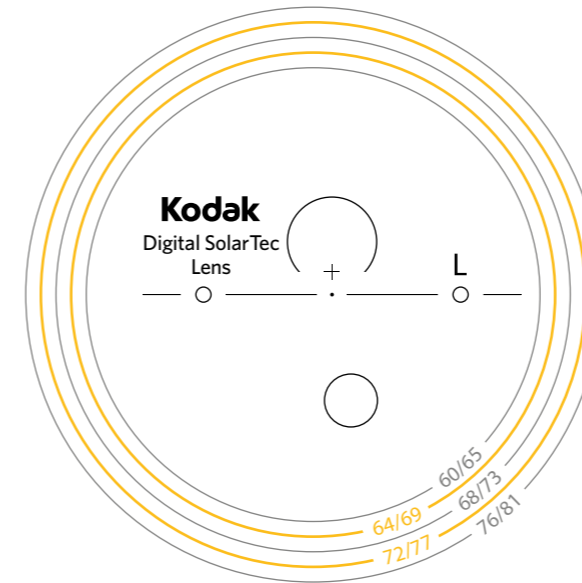

Range	Clear	Polarised	Photoviews	Drivewear	Transitions® Signature™ VII	Transitions® XTRActive™
1.50	✓	✓		✓		✓
1.53						
1.59						
1.60	✓	✓				✓
1.67	✓	✓				✓
1.74						

Minimum Fitting Height	18mm
Corridor Length (mm)	17, 19, 21 (auto select)
Minimum Distance to Top Rim	9mm
Fitting Cross above Prism Reference Point	3mm
Decentred	2.5mm

We offer 6 & 8 base.
Full range information available in the KODAK Lens Range Chart booklet.





Signet Armorlite Europe

1-7 Apollo, Olympus Park
Quedgeley, Gloucester, GL2 4NF
T: 01452 720 201
F: 01452 720 004
www.saeurope.co.uk

HOW TO ORDER

CALL 01452 887 400

EMAIL orders@kodaklens.co.uk

FAX 01452 720 004

ONLINE www.saeurope.co.uk

OR CONTACT YOUR KODAK LENS REGIONAL MANAGER



The KODAK trademark and trade dress are used under license from KODAK by Signet Armorlite, Inc. ©2016. Transitions and the swirl are registered trademarks of Transitions Optical, Inc., used under license by Transitions Optical Limited. ©2016 Transitions Optical Limited. All trademarks and registered trademarks are property of registered users.

Kodak LENS

TRADITIONAL LENSES

HIGH QUALITY LENSES FROM
TRADITIONAL DESIGNS

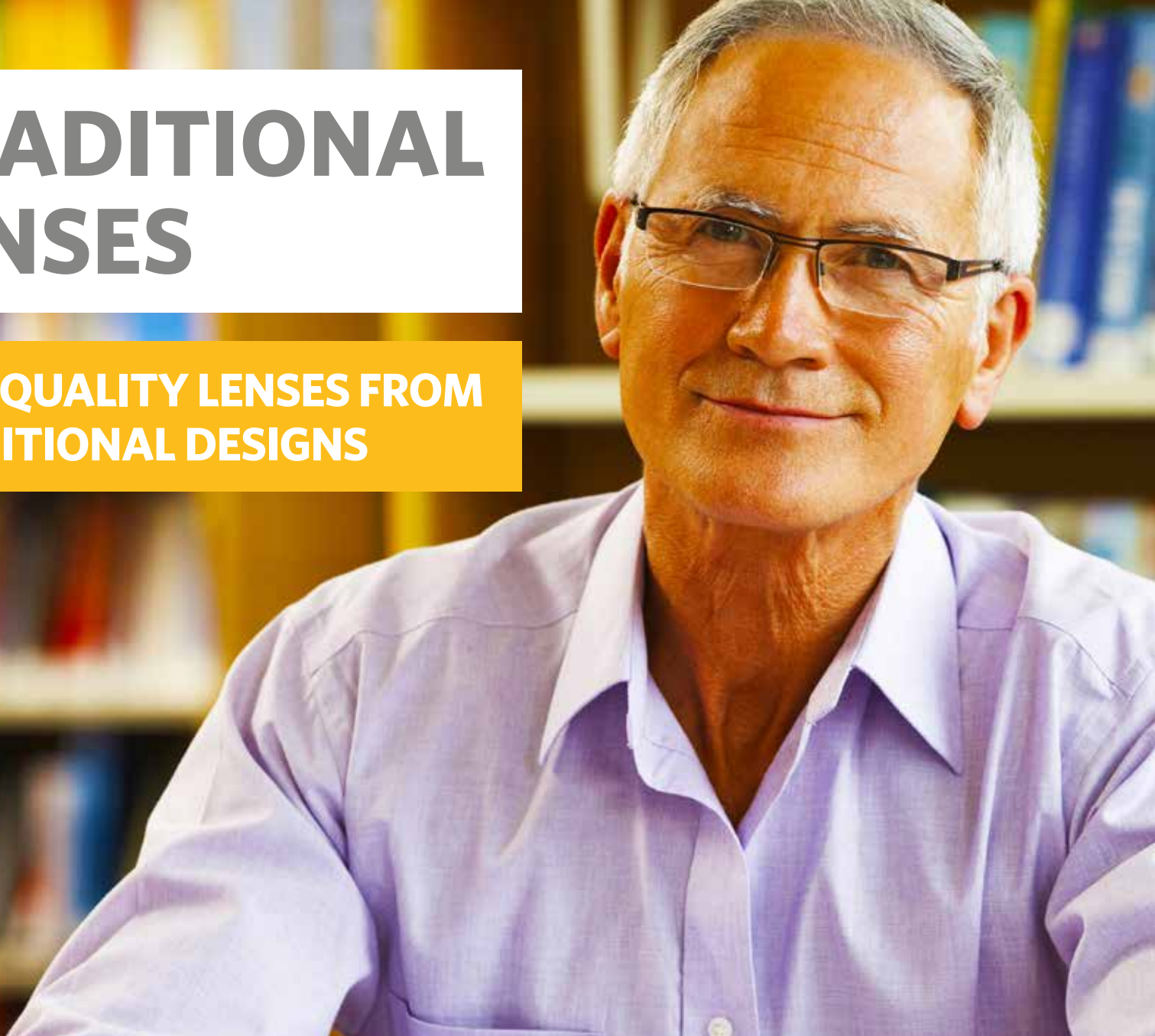

KODAK CONCISE LENSES

A KODAK Concise Lens is an entry level progressive lens that has been designed for shallower frames.

Although these lenses are designed to fit into a shallow frame they still provide a maximum reading area to promote natural eye movement.

WEARER BENEFITS

- Wide near zone for natural eye movement
- Smooth graduation between powers
- Optimised for shallower frames
- Appearance of a single vision lens

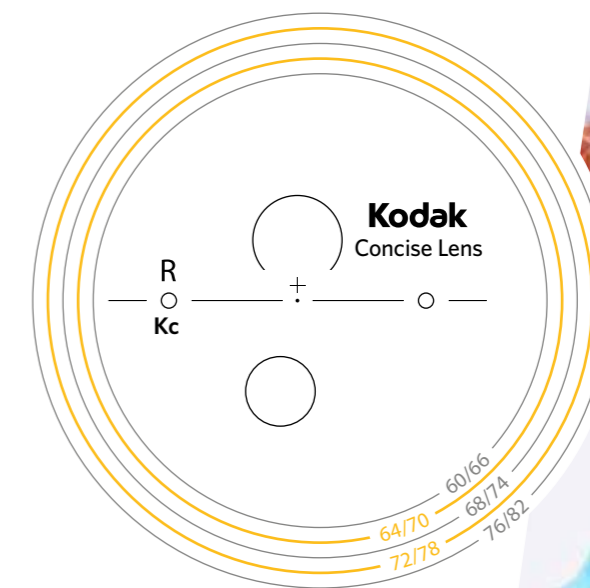
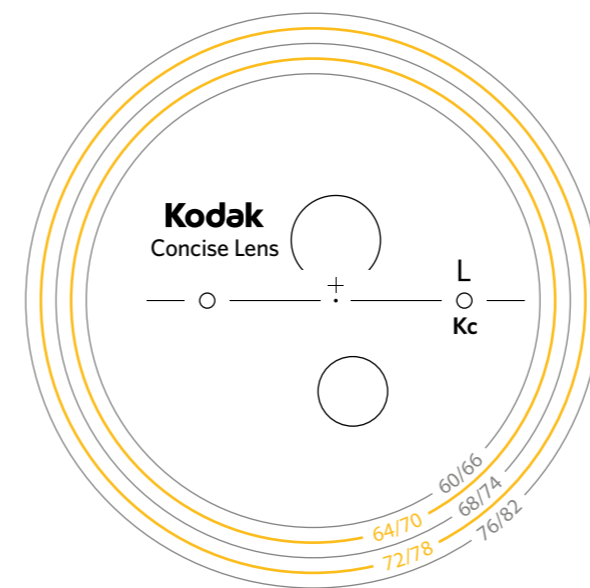

KODAK LENS FINISHES



Clear



Clean&Clear



Clean&Clear UV



BluProtect

Range	Clear	Polarised	Photoviews	Transitions® Signature™ VII	Transitions® XTRActive™
1.50	✓				
1.53					
1.59	✓				
1.60	✓				
1.67	✓				
1.74					

Full range information available in the KODAK Lens Range Chart booklet.

Minimum Fitting Height	15mm
Corridor Length	14mm
Minimum Distance to Top Rim	9mm
Fitting Cross above Prism Reference Point	2mm
Decentred	3mm

KODAK PRECISE LENSES

A KODAK Precise Lens is an entry level progressive lens produced using pre-digital traditional methods.

The lens features a wide near zone for natural eye movement with smooth, controlled power progression throughout all zones. This offers wearers a clear visual experience.

WEARER BENEFITS

- Wide near zone for natural eye movement
- Smooth graduation between powers
- Appearance of a single vision lens

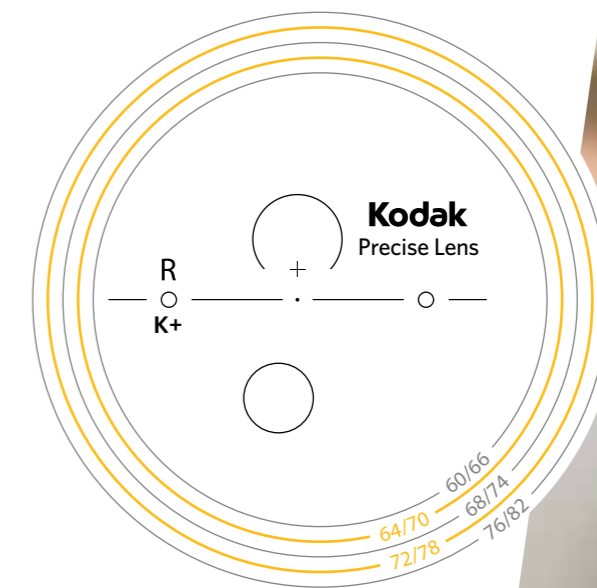
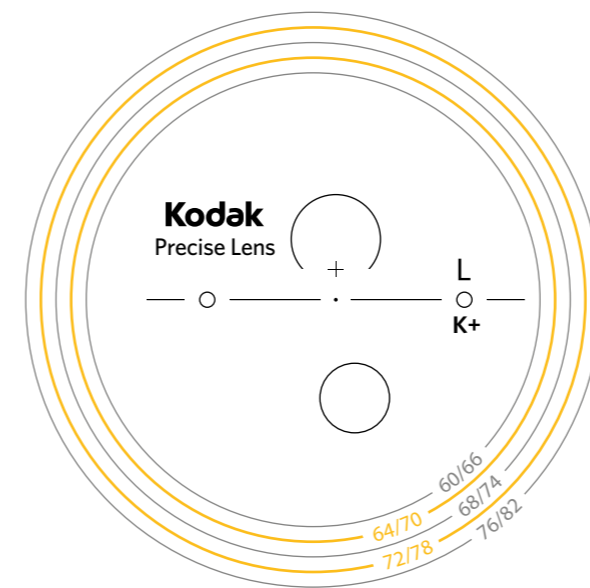

KODAK LENS FINISHES



Clear



Clean&Clear



Clean&Clear UV



BluProtect

Range	Clear	Polarised	Photoviews	Transitions® Signature™ VII	Transitions® XTRActive™
1.50	✓	✓			
1.53					
1.59	✓				
1.60	✓				
1.67	✓				
1.74					

Full range information available in the KODAK Lens Range Chart booklet.

Minimum Fitting Height	18mm
Corridor Length	17mm
Minimum Distance to Top Rim	9mm
Fitting Cross above Prism Reference Point	4mm
Decentred	3mm

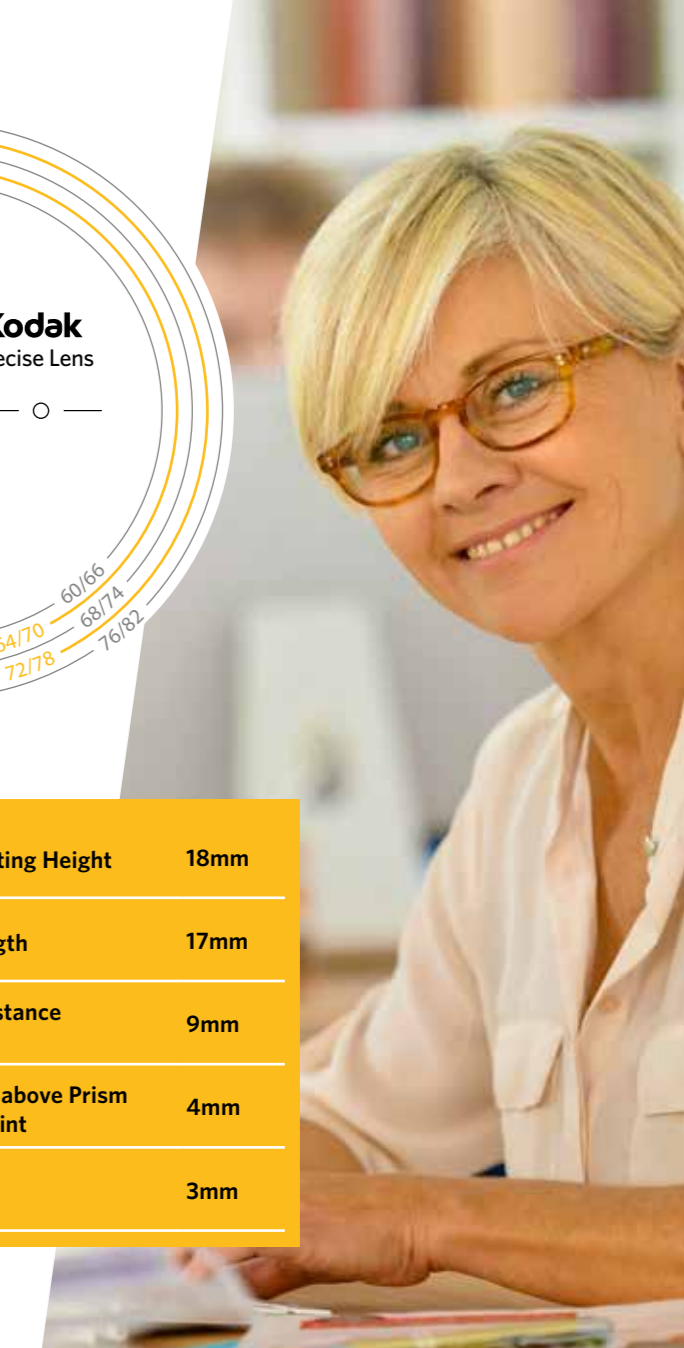

KODAK BIFOCAL LENSES

The KODAK Bifocal Lens range comes with a KODAK Clear Lens finish as standard, offering the patient a lens that reduces irritating glare and reflections on the lenses whilst also improving contrast to give the wearer more accurate colour and depth perception.

WEARER BENEFITS

- A premium bifocal from a trusted brand
- Sharper contrast improves visual perception
- Bright irritating glare is reduced
- Improved visual comfort reduces eye strain
- Annoying reflections are eliminated
- Reflection-free lenses look better



KODAK LENS FINISHES



Clear



Clean&Clear



Clean&Clear UV



BluProtect

AVAILABLE LENSES



Flat top



Curved top

Curved top bifocal available in 1.6 only

Range	Clear	Polarised	Photoviews	Transitions® Signature™ VII	Transitions® XTRActive™
1.50	✓	✓		✓	
1.53					
1.59	✓				
1.60	✓				
1.67	✓				
1.74					

Full range information available in the KODAK Lens Range Chart booklet.





Signet Armorlite Europe

1-7 Apollo, Olympus Park
Quedgeley, Gloucester, GL2 4NF
T: 01452 720 201
F: 01452 720 004
www.saeurope.co.uk

HOW TO ORDER

CALL 01452 887 400

EMAIL orders@kodaklens.co.uk

FAX 01452 720 004

ONLINE www.saeurope.co.uk

OR CONTACT YOUR KODAK LENS REGIONAL MANAGER



The KODAK trademark and trade dress are used under license from KODAK by Signet Armorlite, Inc. ©2016. Transitions and the swirl are registered trademarks of Transitions Optical, Inc., used under license by Transitions Optical Limited. ©2016 Transitions Optical Limited. All trademarks and registered trademarks are property of registered users.

Kodak LENS

DIGITAL SINGLE VISION LENSES

SINGLE PURPOSE VISION CORRECTION



DIGITAL SINGLE VISION

A KODAK Digital Single Vision Lens offers patients optical and cosmetic improvements over traditional lenses. Digital lenses are created using a diamond cutting tool guided by software that uses over 5,000 reference points to shape the lens surface geometry, this leads to better prescription accuracy and clear vision correction right to the very edge of the lens. Digital lenses are also 12% thinner and up to 20% flatter than standard single vision lenses.

A KODAK Digital Single Vision Lens minimises the oblique astigmatic error present in a traditional lens. Very few people will only observe images through the optical centre of the lens, typically most points of gaze will be from 0° to 30°.

By carrying out an eyepoint ray trace on the lens surface the oblique astigmatic error can be calculated at each specific reference point and the atoric surface can be calculated accordingly to ensure that this is reduced to a minimum, providing your patients with the best possible visual acuity in all directions of gaze.

WEARER BENEFITS

- Enhanced prescription accuracy across the entire lens
- Cosmetically superior to traditional lenses which are thicker and heavier
- Wider field of view with less distortion



Conventional Single Vision



KODAK Digital Single Vision Lens

KODAK LENS FINISHES



Clear



Clean&Clear



Clean&Clear UV



BluProtect

CONVENTIONAL SINGLE VISION LENS

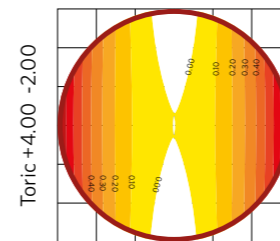
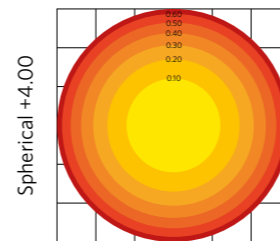

DIGITAL SINGLE VISION LENS

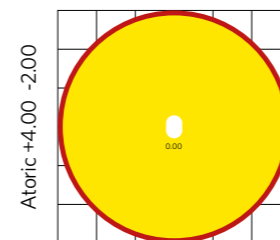
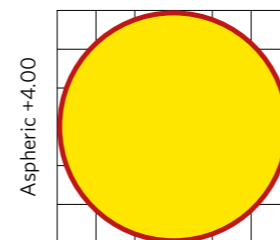

Range	Clear	Polarised	Photoviews	Transitions® Signature™ VII	Transitions® XTRActive™
1.50	✓	✓	✓	✓	✓
1.53	✓			✓	
1.59					
1.60	✓		✓	✓	✓
1.67	✓	✓		✓	✓
1.74	✓			✓*	

*Grey and Brown Only. Full range information available in the KODAK Lens Range Chart booklet.





Signet Armorlite Europe

1-7 Apollo, Olympus Park
Quedgeley, Gloucester, GL2 4NF
T: 01452 720 201
F: 01452 720 004
www.saeurope.co.uk

HOW TO ORDER

CALL 01452 887 400

EMAIL orders@kodaklens.co.uk

FAX 01452 720 004

ONLINE www.saeurope.co.uk

OR CONTACT YOUR KODAK LENS REGIONAL MANAGER



The KODAK trademark and trade dress are used under license from KODAK by Signet Armorlite, Inc. ©2016. Transitions and the swirl are registered trademarks of Transitions Optical, Inc., used under license by Transitions Optical Limited. ©2016 Transitions Optical Limited. All trademarks and registered trademarks are property of registered users.

Kodak LENS

LENS FINISHES

EVERY LENS DESERVES
THE PERFECT FINISH

KODAK CLEAR LENS

A KODAK Clear Lens has an anti-reflective lens finish that efficiently manages how light interacts with the lens. Irritating glare is reduced and reflections on the lenses are eliminated, this improves both the patient's visual experience as well as making their eyes more visible to others which improves the cosmetic appearance of the glasses.

This glare reduction means a patient with a KODAK Clear Lens will find their eyes are less prone to being tired, particularly at the end of the day. The lens finish also increases colour contrast and therefore improves the wearer's visual perception.

If your patient's eyes are irritated by bright office lights or oncoming headlights whilst driving at night for example, recommend this reflection-free finish to help relieve their sensitive eyes.

WEARER BENEFITS

- Better contrast gives more accurate colour and depth perception
- Bright irritating glare is reduced
- Improved visual comfort reduces eye strain
- Annoying reflections are eliminated
- Reflection-free lenses look better

RANGE AVAILABILITY

	1.50	1.53	1.59	1.60	1.67	1.74
Unique HD	✓	✓	✓	✓	✓	✓
Unique	✓	✓	✓	✓	✓	✓
Easy	✓	✓		✓	✓	✓
Precise Digital	✓	✓		✓	✓	✓
Concise Digital	✓	✓		✓	✓	✓
SoftWear	✓			✓	✓	
Precise	✓		✓	✓	✓	
Concise	✓		✓	✓	✓	
DSV	✓	✓		✓	✓	✓
FSV	✓	✓	✓	✓	✓	✓
Anti-fatigue	✓	✓	✓	✓	✓	✓
RXSV	✓		✓	✓	✓	✓
Bifocal	✓		✓	✓	✓	✓

Polarised, Transitions® and materials may vary - see range booklet for more information.

STANDARD LENS

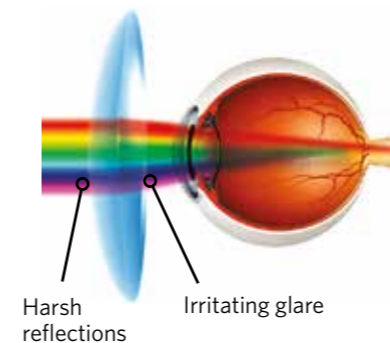

KODAK CLEAR LENS

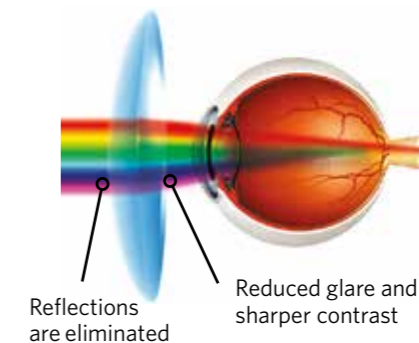

KODAK CLEAR LENS INCLUDES

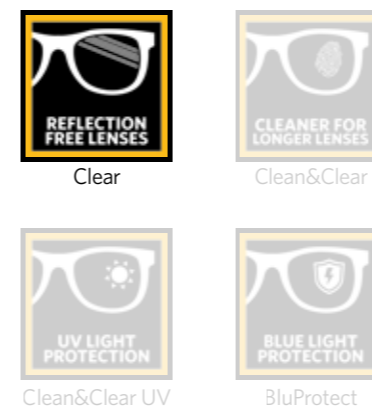

COATING STACK

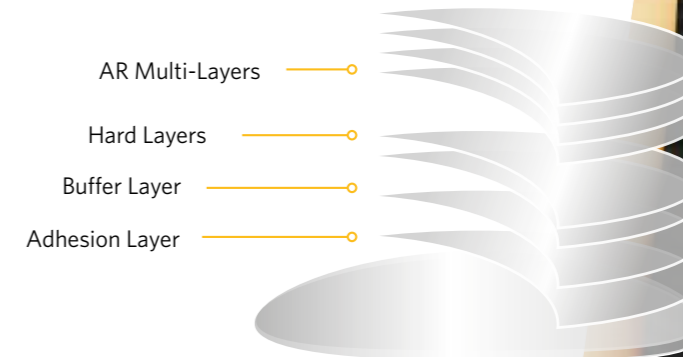

KODAK CLEAN&CLEAR LENS

A KODAK Clean&Clear Lens houses all the benefits of a KODAK Clear Lens but also has been specially developed to actively repel dirt, grime and water. The finish also makes the lenses 10 times easier to clean than lenses with more traditional anti-reflection coatings which means the wearer benefits from clearer smudge-free vision and less frequent cleaning of the lenses.

The 'Clean' layer applied to a KODAK Clean&Clear Lens also provides outstanding scratch resistance. We are so confident in the superb quality of this lens finish that if your patient scratches their KODAK Clean&Clear Lens within 2 years, we will replace them for free! Sensible terms apply of course, see page 10 for more information.

WEARER BENEFITS

- Lenses stay cleaner for longer and are 10 times easier to clean
- 2 year anti-scratch guarantee with free replacements
- Better contrast gives more accurate colour and depth perception
- Bright irritating glare is reduced
- Improved visual comfort reduces eye strain
- Annoying reflections are eliminated
- Reflection-free lenses look better



RANGE AVAILABILITY

	1.50	1.53	1.59	1.60	1.67	1.74
Unique HD	✓	✓	✓	✓	✓	✓
Unique	✓	✓	✓	✓	✓	✓
Easy	✓	✓		✓	✓	✓
Precise Digital	✓	✓		✓	✓	✓
Concise Digital	✓	✓		✓	✓	✓
SoftWear	✓			✓	✓	
Precise	✓		✓	✓	✓	
Concise	✓		✓	✓	✓	
DSV	✓	✓		✓	✓	✓
FSV	✓			✓	✓	✓
Anti-fatigue	✓	✓	✓	✓	✓	✓
RXSV	✓		✓	✓	✓	✓
Bifocal	✓		✓	✓	✓	

Polarised, Transitions® and materials may vary - see range booklet for more information.

STANDARD LENS

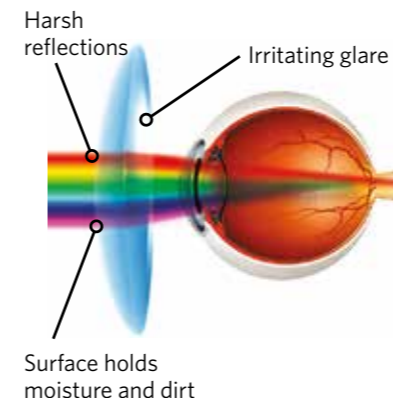

KODAK CLEAN&CLEAR LENS

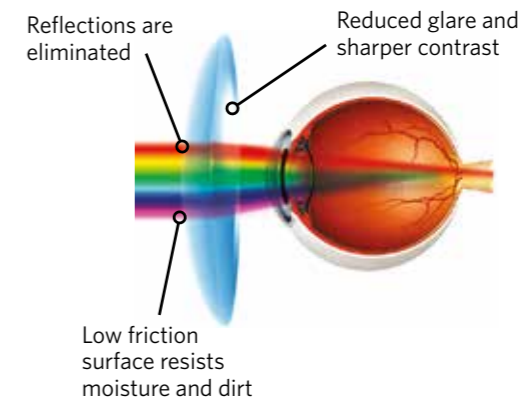

KODAK CLEAN&CLEAR LENS INCLUDES



Clear



Clean&Clear



Clean&Clear UV



BluProtect

COATING STACK

- High Friction Layer
- Super Hydrophobic /Oleophobic Layer
- AR Multi-Layers
- Hard Layers
- Buffer Layer
- Adhesion Layer

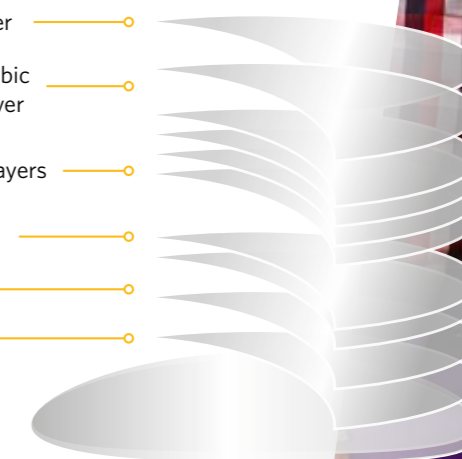

KODAK CLEAN&CLEAR UV LENS

A KODAK Clean&Clear UV Lens offers patients all the benefits of a KODAK Clean&Clear Lens as well as protecting their eyes from the degenerative damage and other serious health risks associated with exposure to UV light. The anti-reflective technology greatly reduces UV light transmission through the front surface of the lens whilst also absorbing dangerous rear surface UV reflections that would otherwise penetrate the unprotected eye.

Offer your patients a KODAK Clean&Clear UV Lens to provide them with UV protection, increased visual performance and reduced eye strain in a lens that also resists dirt, smudging, scratches and dust.

We are so confident in the superb quality of this lens that if your patient scratches their lenses within 2 years, we will replace them for free! Sensible terms apply of course, see page 10 for more information.

WEARER BENEFITS

- Exceptional protection from harmful UV light
- Lenses stay cleaner for longer and are 10 times easier to clean
- 2 year anti-scratch guarantee with free replacements
- Better contrast gives more accurate colour and depth perception
- Bright irritating glare is reduced and reflections are eliminated
- Improved visual comfort reduces eye strain
- Reflection-free lenses look better

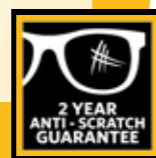

RANGE AVAILABILITY

	1.53	1.59	1.60	1.67	1.74
Unique HD	✓	✓	✓	✓	✓
Unique	✓	✓	✓	✓	✓
Easy	✓		✓	✓	✓
Precise Digital	✓		✓	✓	✓
Concise Digital	✓		✓	✓	✓
SoftWear			✓	✓	
Precise		✓	✓	✓	
Concise		✓	✓	✓	
DSV	✓		✓	✓	✓
Anti-fatigue	✓	✓	✓	✓	✓
RXSV		✓	✓	✓	✓
Bifocal		✓	✓	✓	

Polarised, Transitions® and materials may vary - see range booklet for more information.

STANDARD LENS

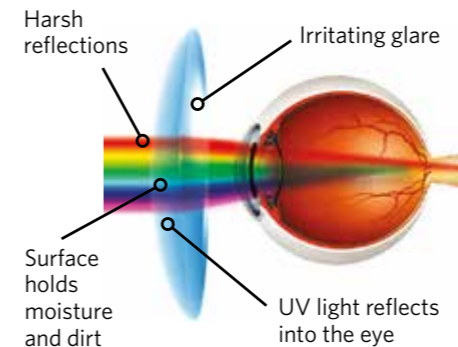

KODAK CLEAN&CLEAR UV LENS

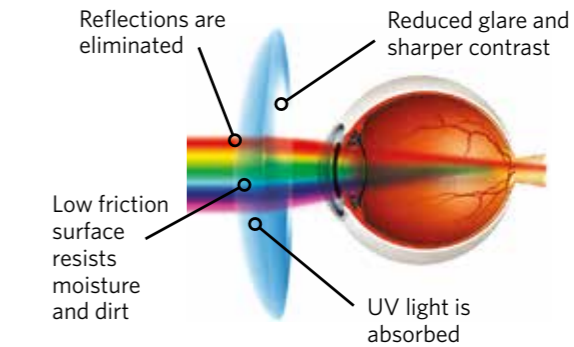

KODAK CLEAN&CLEAR UV LENS INCLUDES

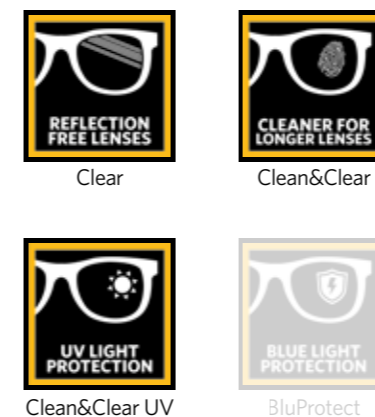

COATING STACK

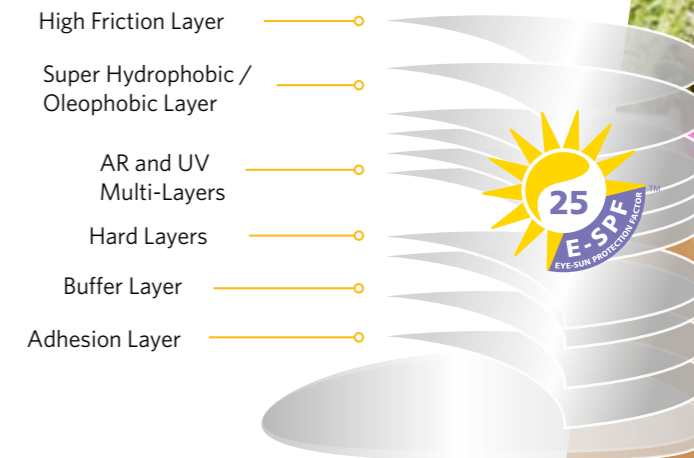

KODAK BLUPROTECT LENS

Prolonged exposure to high energy blue light has been linked to a number of serious eye conditions such as cataracts and age-related macular degeneration (AMD) as well as less serious ailments such as eye strain and headaches. Exposure to artificial blue light during naturally dark periods from computers, televisions, smart phones or artificial lighting also affects the body's production of a hormone called melatonin, which can disrupt natural sleeping patterns.

A KODAK BluProtect Lens shields the patient's eyes by filtering out harmful blue light without distorting colour vision or disturbing positive light wavelengths. Light entering the eye is more efficiently managed, leading to less eye strain and more comfortable viewing over longer periods of time. These lenses are also covered by our 2 year anti-scratch guarantee (see page 10 for more information).

WEARER BENEFITS

- Eyes are protected from the strain and damage linked to blue light
- Reduced exposure at night helps to promote natural sleep patterns
- Lenses stay cleaner for longer and are 10 times easier to clean
- 2 year anti-scratch guarantee with free replacements
- Better contrast gives more accurate colour and depth perception
- Bright irritating glare is reduced and reflections are eliminated
- Clear lens glasses with clean, reflection free lenses look better



RANGE AVAILABILITY

	1.50	1.53	1.59	1.60	1.67	1.74
Unique HD	✓	✓	✓	✓	✓	✓
Unique	✓	✓	✓	✓	✓	✓
Easy	✓	✓		✓	✓	✓
Precise Digital	✓	✓		✓	✓	✓
Concise Digital	✓	✓		✓	✓	✓
SoftWear	✓			✓	✓	
Precise	✓		✓	✓	✓	
Concise	✓		✓	✓	✓	
DSV	✓	✓		✓	✓	✓
FSV	✓			✓		
Anti-fatigue	✓	✓	✓	✓	✓	✓

Polarised, Transitions® and materials may vary - see range booklet for more information.

STANDARD LENS

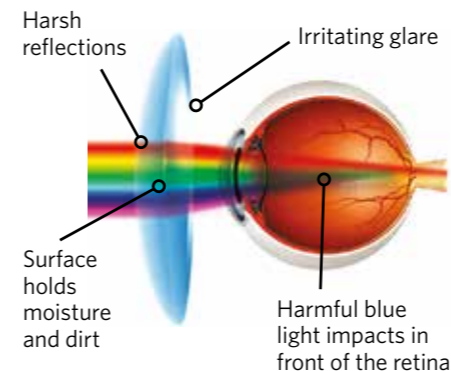

KODAK BLUPROTECT LENS

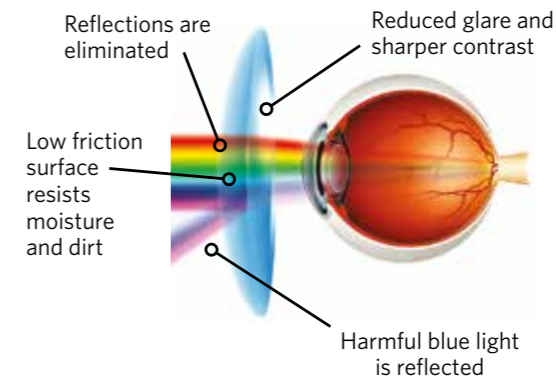

KODAK BLUPROTECT LENS INCLUDES



Clear



Clean&Clear



Clean&Clear UV



BluProtect

COATING STACK

- High Friction Layer
- Super Hydrophobic /Oleophobic Layer
- AR Multi-Layers with BluProtect
- Hard Layers
- Buffer Layer
- Adhesion Layer

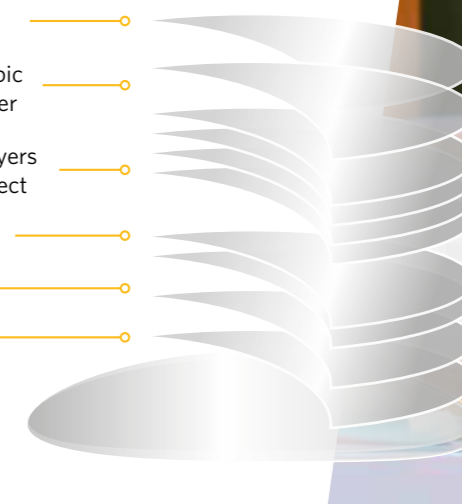

REASSURE YOUR PATIENTS WITH THE KODAK LENS — 2 YEAR — ANTI-SCRATCH GUARANTEE

This is separate to our standard guarantee against manufacturing defects. Under this guarantee, your patient can scratch their lenses, return to you and have them replaced by us FREE OF CHARGE. The same prescription and patient information will need to apply to the replacement lenses of course.

Applicable products only. Terms and conditions apply.



Every lens ordered with KODAK Clean&Clear, KODAK BluProtect or KODAK Clean&Clear UV on or after 28th August 2015 will be supplied with a 'no quibble' anti-scratch guarantee valid for 2 years.

IT'S SIMPLE

1. You re-order identical lenses, we charge.
2. You return the scratched lenses, we credit*

*Credit excludes extra services such as glazing

PATIENT TERMS & CONDITIONS

If your KODAK Clean & Clear, KODAK Clean & Clear UV or KODAK BluProtect lenses are scratched within the 2 year guarantee period as specified below, we will replace those lenses for free with an identical lens product and prescription.

- a) This guarantee is valid for lenses despatched from Signet Armorlite Ltd (SAE Ltd) on or after 28/08/2015.
- b) This guarantee applies to KODAK lenses complete with KODAK Clean & Clear, KODAK Clean & Clear UV and KODAK BluProtect lens coatings only.
- c) This guarantee is valid for two years from the recorded date of despatch from SAE Ltd to the dispensing optician.
- d) This guarantee is separate from, and does not affect, the standard 2 year guarantee against manufacturing defects supplied with every KODAK Lens product.
- e) Replacement lenses are supplied identical to the original order received by SAE Ltd, this includes identical prescription and matching patient details only.

- f) In the event that an identical replacement lens is not available due to discontinuation or unavailability of the product, a lens of equal or greater value will be offered.
- g) The guarantee is non-transferable, cannot be sold and there is no cash alternative.
- h) This guarantee covers the applicable lenses only and does not cater for, or extend to, the repair of frames or create a provision for replacement frames.
- i) This guarantee does not affect your statutory rights.

Promoter: Signet Armorlite Europe Limited (SAE Ltd), registered in England and Wales under number 2108102, Registered office 1-7 Apollo, Olympus Park, Quedgeley Gloucestershire, GL2 4NF, England. VAT registration GB 477 7764 79 KODAK and the KODAK trade dress are the trademarks of KODAK used under license by Signet Armorlite, Inc. T: +44 (0) 1452 88 7400.





Signet Armorlite Europe

1-7 Apollo, Olympus Park
Quedgeley, Gloucester, GL2 4NF
T: 01452 720 201
F: 01452 720 004
www.saeurope.co.uk

HOW TO ORDER

CALL 01452 887 400

EMAIL orders@kodaklens.co.uk

FAX 01452 720 004

ONLINE www.saeurope.co.uk

OR CONTACT YOUR KODAK LENS REGIONAL MANAGER



The KODAK trademark and trade dress are used under license from KODAK by Signet Armorlite, Inc. ©2016. Transitions and the swirl are registered trademarks of Transitions Optical, Inc., used under license by Transitions Optical Limited. ©2016 Transitions Optical Limited. All trademarks and registered trademarks are property of registered users.

Kodak LENS

SUN LENSES AND TINTS

COMFORT, STYLE
AND PROTECTION



KODAK MIRROR TINTS

Whether your patient is looking for abrasion-resistant performance lenses for their favourite sport or stylish lenses for prowling the high street, KODAK Lens Mirror Tints are a great choice.

Mirror lenses are perfect for reducing harsh outdoor light, such as direct or reflected sunlight. They deflect light away from the eye more efficiently than the standard absorption of a tinted lens and are ideal for people who are light-sensitive.



WEARER BENEFITS

- Stylish and fashionable
- Deflects bright glare from direct or indirect sunlight
- Great for outdoor sports, especially those involving water or snow

KODAK LENS FINISHES



Clear



Clean&Clear



Clean&Clear UV



BluProtect

COLOURS AVAILABLE



Sapphire blue



Gold



Silver



Green

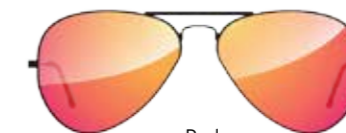

Red

AVAILABILITY

Unique HD	Unique	Easy	Precise Digital	Concise Digital	Soft-Wear	Precise	Concise	DSV	FSV	Anti-fatigue	Bifocal	RXSV
✓	✓	✓	✓	✓	✓	✓	✓	✓		✓	✓	✓

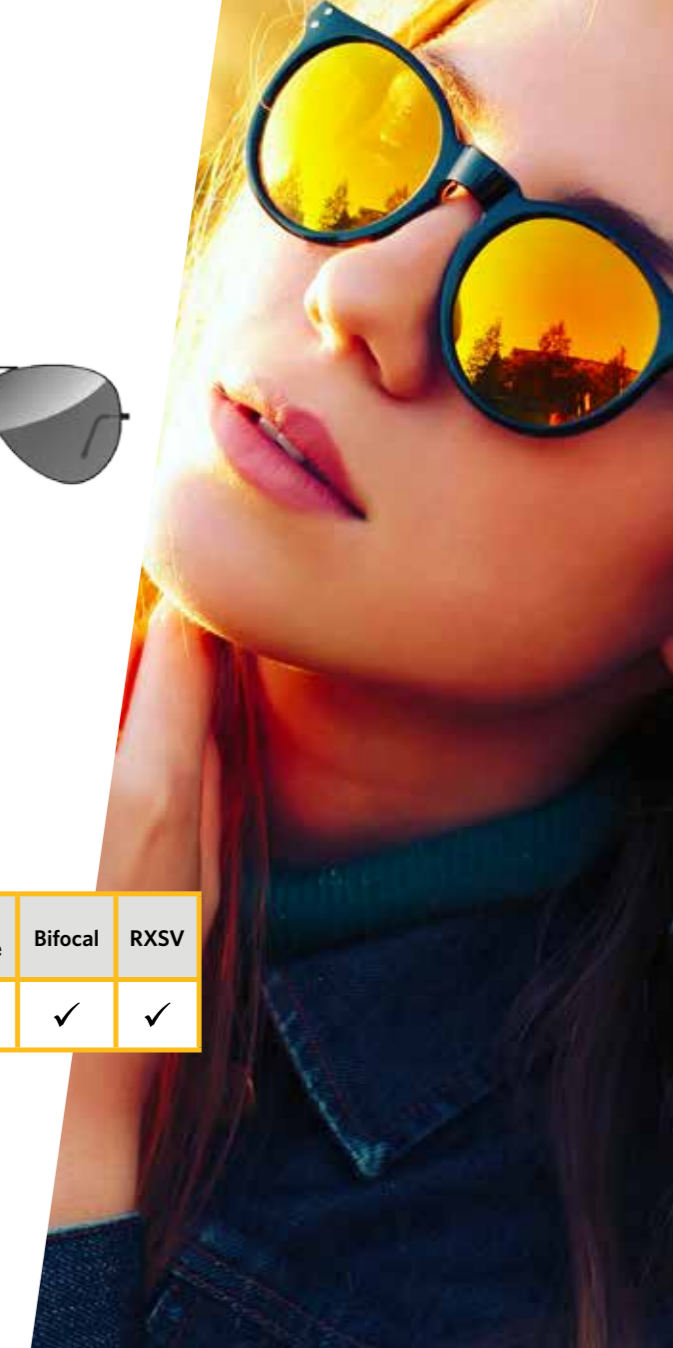

KODAK UVSUN POLARISED LENSES

KODAK UVSun Polarised Lenses greatly reduce harsh reflected glare and whilst also protecting the patients from harmful UV rays.

An extremely thin layer of film with vertical rows of iodine crystals is applied to the lens surface, creating a Venetian blind effect that deflects vision killing glare but still allows the useful rays to pass through to your eyes. Harsh light is usually reflected off wet roads, water, snow, glass and metal making these lenses ideal for driving, skiing, fishing and many more outdoor activities.

WEARER BENEFITS

- Clear, comfortable sight is maintained in the brightest of situations
- Better contrast gives more accurate colour and depth perception
- The eyes are protected from UV rays
- Driving in bright conditions is made safer
- Excellent for outdoor sports such as trekking, cycling, skiing and fishing
- Thin and light lenses
- 3 colours to choose from

AVAILABILITY

Unique HD	Unique	Easy	Precise Digital
✓	✓	✓	✓
Concise Digital	Soft-Wear	Precise	Concise
✓		✓	
DSV	FSV	Anti-fatigue	
✓			
Bifocal	RXSV		
✓	✓		

COLOURS AVAILABLE

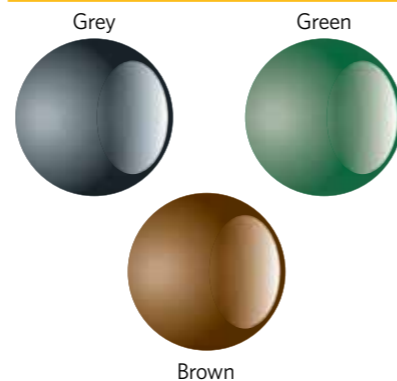

KODAK LENS TINTS

KODAK Lens offer one of the broadest ranges of coloured tints, from the traditional brown and greys to the more specific colours, such as green or yellow. A colour tint can enhance the visual performance of spectacles for certain sports or activities. There is no certain rule for which colour tint best suits which sport but a brief guide based on our experience is below.

- **Skiing** **Brown, Red/Orange or Grey**
- **Golf** **Green or Grey**
- **Tennis** **Green**
- **Running** **Green or Grey**
- **Cycling** **Yellow**

Pre-Tinted 1.50 and 1.60 FSV Lenses

Convenient and quicker than tint baths, pre-tinted lenses offer improved colour consistency. Available in 1.5 uncoated and back-surface AR and 1.6 back-surface AR in grey, brown and green.

See range charts for power range availability.

Blueblocker

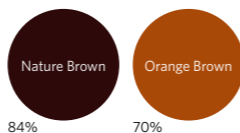
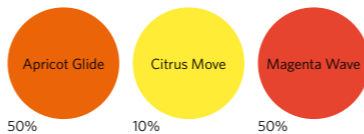

Specialist

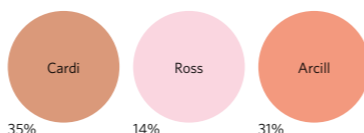
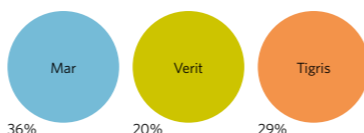
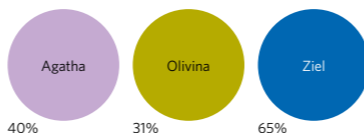

Brown

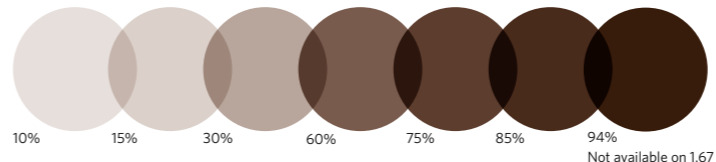

Grey

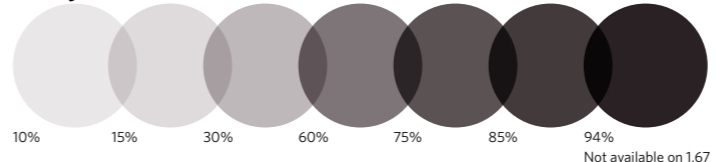

Grey-Green

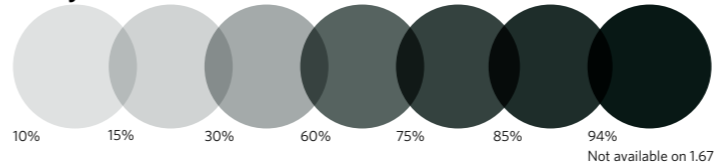

Graphite Green

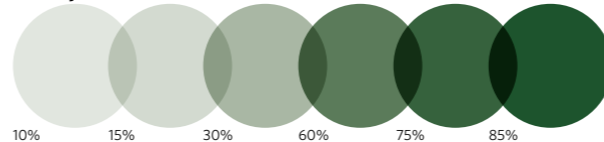

Blue

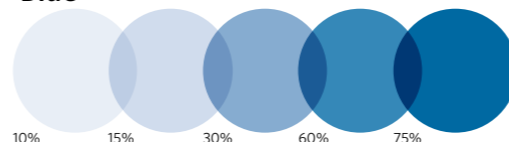

Gradient

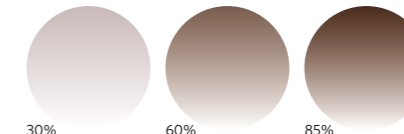

Gradient

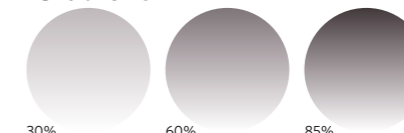

Gradient

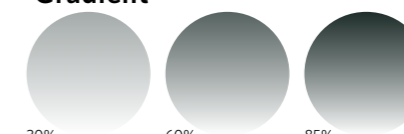

Gradient

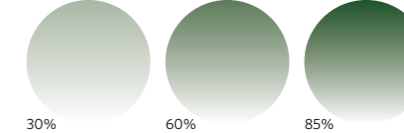

Gradient



Due to reprographic process, colours shown are for indication only, and may not match exactly. Tints may also be affected by lens prescription, index and coatings.





Signet Armorlite Europe

1-7 Apollo, Olympus Park
Quedgeley, Gloucester, GL2 4NF
T: 01452 720 201
F: 01452 720 004
www.saeurope.co.uk

HOW TO ORDER

CALL 01452 887 400

EMAIL orders@kodaklens.co.uk

FAX 01452 720 004

ONLINE www.saeurope.co.uk

OR CONTACT YOUR KODAK LENS REGIONAL MANAGER



The KODAK trademark and trade dress are used under license from KODAK by Signet Armorlite, Inc. ©2016. Transitions and the swirl are registered trademarks of Transitions Optical, Inc., used under license by Transitions Optical Limited. ©2016 Transitions Optical Limited. All trademarks and registered trademarks are property of registered users.

Kodak LENS

PHOTOCHROMIC LENSES

COMFORT AND PROTECTION FROM
LENSES THAT ADAPT TO CHANGING
LIGHT THROUGHOUT THE DAY



KODAK PHOTOVIEWS LENSES

KODAK Photoviews are an effective entry level photochromic lens for comfortable vision in any light conditions, whether in the office, at home or in the garden.

The lenses provide full UV light protection and feature a fade-back time of 5 minutes.

These light reactive photochromic lenses adjust to the lighting conditions to protect the patient's eyes and improve visual comfort throughout the day.

WEARER BENEFITS

- Full UVA and UVB protection
- Better clarity indoors and outdoors
- Comfortable vision in any light
- Dark tint outdoors
- Ideal for everyday wear

AVAILABILITY

1.50 and 1.60 index

Unique HD	Unique	Easy	Precise Digital
✓	✓	✓	✓
Concise Digital	Soft-Wear	Precise	Concise
✓			
DSV	FSV	Anti-fatigue	Bifocal
✓			

KODAK LENS FINISHES



Clear



Clean&Clear



Clean&Clear UV



BluProtect



TRANSITIONS® SIGNATURE™ LENSES

Transitions® Signature™ lenses block UV rays and adapt to changing light throughout the day to reduce glare, eye fatigue and eye strain. The lenses quickly adapt from fully clear indoors to dark outdoors and back again. This latest generation; Signature™ VII, benefits from a new 8-dye molecular technology which means the lenses are more responsive than ever, reacting to indirect sunlight and increasing the reaction (darkness) on hotter, brighter days.

The quick adaption, health benefits and improved visual comfort mean that Transitions® Signature™ lenses offer your patients distinct advantages over standard clear lenses. Every Transitions® lens is also covered by our 30 day 'love them or exchange' guarantee.

WEARER BENEFITS

- Clear vision indoors and at night time
- Comfortable vision in bright outdoor conditions
- Reduced glare, eye fatigue and eye strain throughout the day
- Fast fade-back speed when going back indoors
- 100% protection from harmful UVA and UVB rays
- Improved performance in hot climates
- 30 day love them or exchange them guarantee

Transitions®
Signature™ VII

**30 DAY
LOVE THEM
OR EXCHANGE
GUARANTEE**

ON ALL GLASSES WITH
TRANSITIONS® LENSES

KODAK LENS FINISHES



Clear



Clean&Clear



Clean&Clear UV



BluProtect

DID YOU KNOW?



A PAIR OF TRANSITIONS®
LENSES ARE SOLD
EVERY SECOND
WORLDWIDE



TRANSITIONS® LENSES
BLOCK 100%
OF HARMFUL UVA
AND UVB RAYS

92% ✓
RENEWAL RATE

MORE THAN → **95%**
OF PATIENTS WHO PURCHASE
TRANSITIONS® LENSES
ARE SATISFIED

AVAILABLE IN

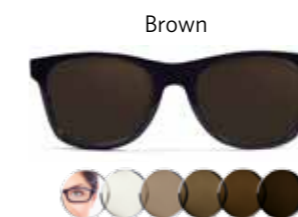

AVAILABILITY

Unique HD*	Unique*	Easy	Precise Digital	Concise Digital	Soft-Wear	Precise	Concise	DSV	FSV	Anti-fatigue	Bifocal	RXSV
✓	✓	✓	✓	✓				✓	✓	✓	✓	✓

*1.74 available in Unique and Unique HD only.



TRANSITIONS® XTRACTIVE™ LENSES

Transitions® XTRActive® lenses offer patients extra protection from harsh light indoors, outdoors and even behind the windshield of a car. Most photochromic lenses only react to UV light which is why they react in the sun and remain clear indoors.

Transitions® XTRActive® lenses feature a broad spectrum dye specially designed to react to both UV and visible light. This offers your patients a superior visual experience that will quickly adapt to all light conditions to reduce glare, prevent eye fatigue and block UV rays. Transitions® XTRActive® lenses are perfect for anyone who is generally light sensitive or spends a lot of time driving or outdoors.

WEARER BENEFITS

- Clear, easy vision in the brightest outdoor conditions
- Slight tint indoors protects wearers from harsh artificial lighting
- Comfortable viewing behind a car windscreen
- Reduced glare, eye fatigue and eye strain throughout the day
- Fast fade-back speed when going back indoors
- 100% protection from harmful UVA and UVB rays
- Improved performance in hot climates
- 30 day love them or exchange them guarantee

Transitions®
XTRActive®

**30 DAY
LOVE THEM
OR EXCHANGE
GUARANTEE**

ON ALL GLASSES WITH
TRANSITIONS® LENSES

KODAK LENS FINISHES



Clear



Clean&Clear



Clean&Clear UV



BluProtect

DID YOU KNOW?



TRANSITIONS® XTRACTIVE™ LENSES HAVE A HINT OF TINT INDOORS THAT HELPS PROTECT EYES FROM HARSH INDOOR LIGHTING, HELPING TO REDUCE EYESTRAIN AND FATIGUE



3 OUT OF 5 TRANSITIONS® XTRACTIVE™ WEARERS PERCEIVE THE HINT OF TINT AND 3 OUT OF 4 WEARERS WERE SATISFIED WITH INDOOR CLARITY



9/10 ECPs AGREE

EVEN THOUGH TRANSITIONS® XTRACTIVE™ LENSES DON'T BLOCK BLINDING GLARE BEHIND THE WINDSCREEN - THEY WOULD STILL BENEFIT PATIENTS MORE THAN A CLEAR LENS WOULD



80%

OF TRANSITIONS® XTRACTIVE™ WEARERS WERE SATISFIED WITH THE LEVEL OF TINT WHEN DRIVING IN SUNNY CONDITIONS

AVAILABLE IN

Grey



Brown



Graphite Green



AVAILABILITY

Unique HD	Unique	Easy	Precise Digital	Concise Digital	Soft-Wear	Precise	Concise	DSV	FSV	Anti-fatigue	Bifocal	RXSV
✓	✓	✓	✓	✓				✓				



Signet Armorlite Europe

1-7 Apollo, Olympus Park
Quedgeley, Gloucester, GL2 4NF
T: 01452 720 201
F: 01452 720 004
www.saeurope.co.uk

HOW TO ORDER

CALL 01452 887 400

EMAIL orders@kodaklens.co.uk

FAX 01452 720 004

ONLINE www.saeurope.co.uk

OR CONTACT YOUR KODAK LENS REGIONAL MANAGER



The KODAK trademark and trade dress are used under license from KODAK by Signet Armorlite, Inc. ©2016. Transitions and the swirl are registered trademarks of Transitions Optical, Inc., used under license by Transitions Optical Limited. ©2016 Transitions Optical Limited. All trademarks and registered trademarks are property of registered users.

Kodak LENS

A rack of colorful eyeglasses in a store. The glasses are hanging on a pink rack with circular holes. The colors of the frames include red, teal, and white. The background is blurred, showing more glasses and store shelves.

KODAK LENS RANGE CHARTS

**SIMPLY SEE THE AVAILABILITY
OF EACH PRODUCT**

DIGITAL PROGRESSIVE LENSES

LENS: **All digital progressive**
 INDEX: **1.50**
 MATERIAL:
 COLOURS:

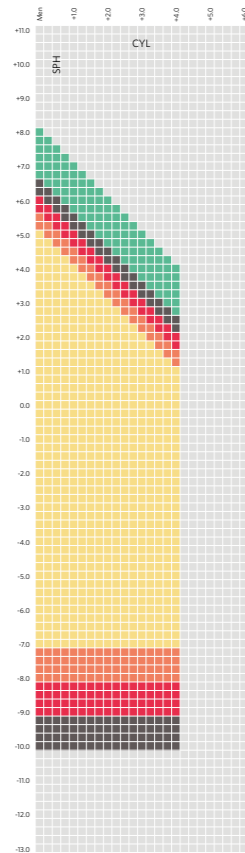

Dia.	Max. minus	Max. plus
50/56	-10.00	+8.00
55/61	-10.00	+8.00
60/66	-10.00	+6.50
65/71	-9.00	+6.00
70/76	-8.00	+5.50
75/81	-7.00	+5.00
Add. 0.75 - 3.50		

LENS: **All digital progressive**
 INDEX: **1.50**
 MATERIAL: **Polarised**
 COLOURS: **Green/Grey/Brown**

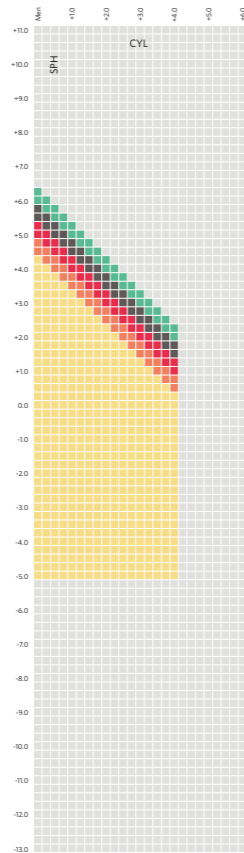

Dia.	Max. minus	Max. plus
50/56	-5.00	+6.25
55/61	-5.00	+6.25
60/66	-5.00	+5.75
65/71	-5.00	+5.25
70/76	-5.00	+4.75
76/82	-5.00	+4.25
Add. 0.75 - 3.50		

LENS: **All digital progressive**
 INDEX: **1.50**
 MATERIAL: **Transitions®**
 COLOURS: **Green/Grey/Brown**

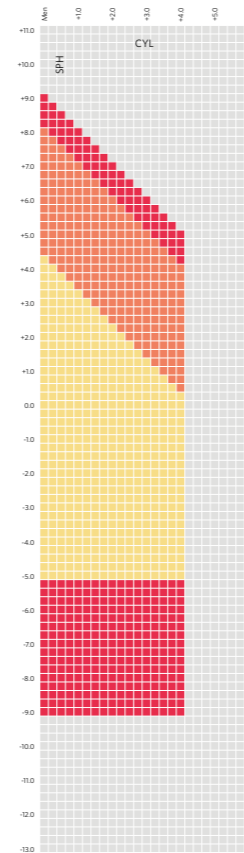

Dia.	Max. minus	Max. plus
50/56	-9.00	+9.00
55/61	-9.00	+9.00
60/66	-9.00	+9.00
65/71	-9.00	+9.00
70/76	-5.00	+8.00
76/82	-5.00	+4.25
Add. 0.75 - 3.50		

LENS: **All digital progressive**
 INDEX: **1.50**
 MATERIAL: **Transitions® XTRActive™**
 COLOURS: **Green/Grey/Brown**

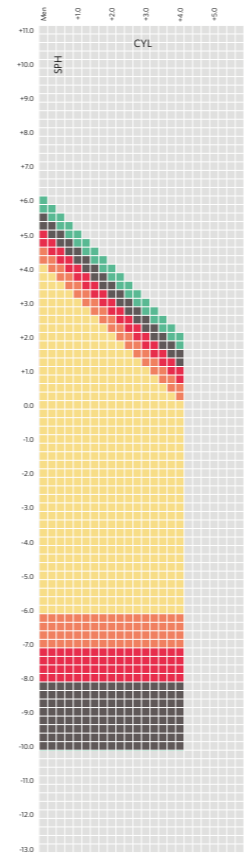

Dia.	Max. minus	Max. plus
50/56	-9.00	+6.00
55/61	-9.00	+6.00
60/66	-9.00	+5.50
65/71	-8.00	+5.00
70/76	-7.00	+4.50
76/82	-6.00	+4.00
Add. 0.75 - 3.50		

LENS: **All digital progressive**
 INDEX: **1.50**
 MATERIAL: **PhotoViews**
 COLOURS: **Grey/Brown**

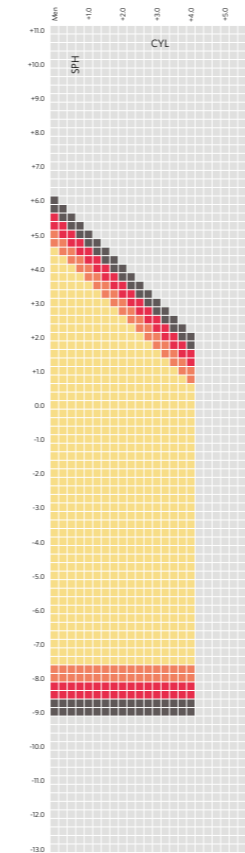

Dia.	Max. minus	Max. plus
50/56	-9.00	+6.00
55/61	-9.00	+6.00
60/66	-9.00	+6.00
65/71	-8.50	+5.50
70/76	-8.00	+5.00
75/81	-7.50	+4.50
Add. 0.75 - 3.50		

LENS: **All digital progressive**
 INDEX: **1.53**
 MATERIAL: **Trivex**
 COLOURS:

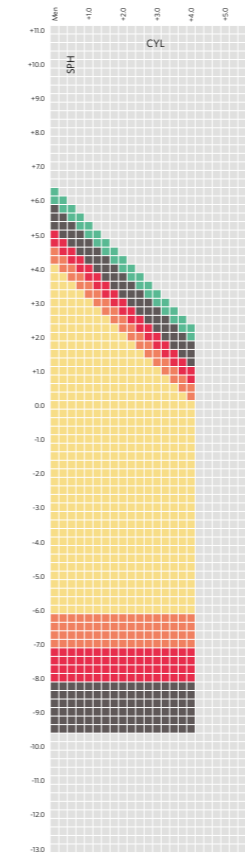

Dia.	Max. minus	Max. plus
50/56	-9.50	+6.25
55/61	-9.50	+6.25
60/66	-9.50	+5.75
65/71	-8.00	+5.00
70/76	-7.00	+4.50
75/81	-6.00	+4.00
Add. 0.75 - 3.50		

LENS: **All digital progressive**
 INDEX: **1.53**
 MATERIAL: **Trivex Transitions®**
 COLOURS: **Grey/Brown**

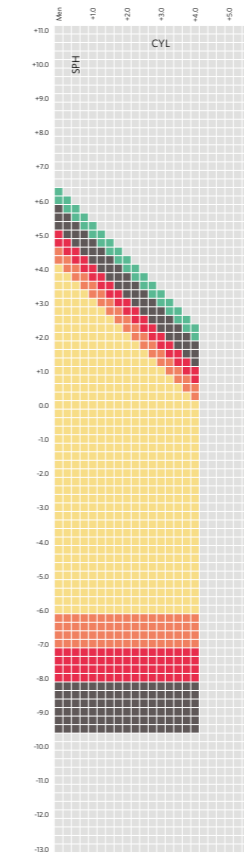

Dia.	Max. minus	Max. plus
50/56	-9.50	+6.25
55/61	-9.50	+6.25
60/66	-9.50	+5.75
65/71	-8.00	+5.00
70/76	-7.00	+4.50
75/81	-6.00	+4.00
Add. 0.75 - 3.50		

LENS: **All digital progressive**
 INDEX: **1.59**
 MATERIAL: **Polycarbonate**
 COLOURS:

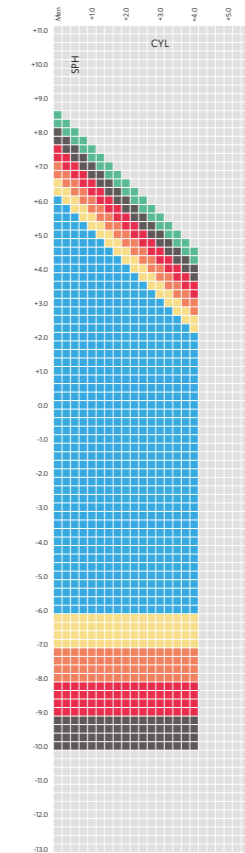

Dia.	Max. minus	Max. plus
50/56	-10.00	+8.50
55/61	-10.00	+8.50
60/66	-10.00	+8.00
65/71	-9.00	+7.50
70/76	-8.00	+7.00
75/81	-7.00	+6.50
80/86	-6.00	+6.00
Add. 0.75 - 3.50		



DIGITAL PROGRESSIVE LENSES

LENS: **All digital progressive**
 INDEX: **1.60**
 MATERIAL:
 COLOURS:

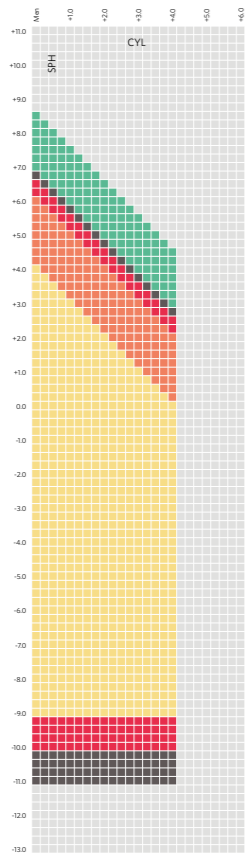

Dia.	Max. minus	Max. plus
50/56	-11.00	+8.50
55/61	-11.00	+8.50
60/66	-11.00	+6.75
65/71	-10.00	+6.50
70/76	-9.00	+6.00
75/81	-9.00	+4.00

Add. 0.75 - 3.50

LENS: **All digital progressive**
 INDEX: **1.60**
 MATERIAL: **Polarised**
 COLOURS: **Green*/Grey/Brown**

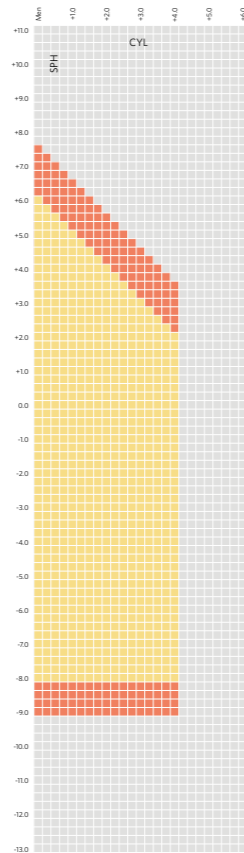

Dia.	Max. minus	Max. plus
50/56	-9.00	+7.50
55/61	-9.00	+7.50
60/66	-9.00	+7.50
65/71	-9.00	+7.50
70/76	-9.00	+7.50
76/82	-8.00	+6.00

Add. 0.75 - 3.50

LENS: **All digital progressive**
 INDEX: **1.60**
 MATERIAL: **Transitions®**
 COLOURS: **Green/Grey/Brown**

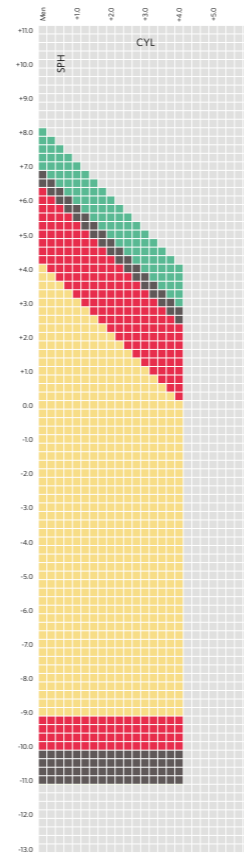

Dia.	Max. minus	Max. plus
50/56	-11.00	+8.00
55/61	-11.00	+8.00
60/66	-11.00	+6.75
65/71	-10.00	+6.25
70/76	-9.00	+4.00
75/81	-9.00	+4.00

Add. 0.75 - 3.50

LENS: **All digital progressive**
 INDEX: **1.60**
 MATERIAL: **Transitions® XTRActive™**
 COLOURS: **Green/Grey/Brown**

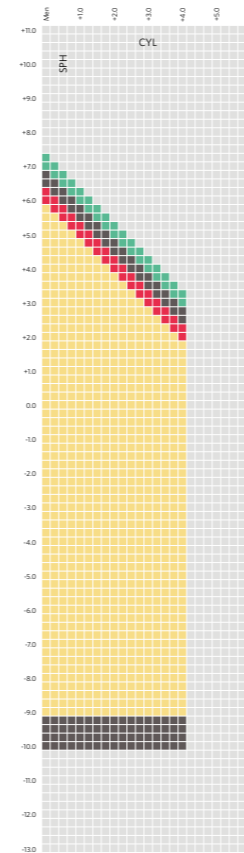

Dia.	Max. minus	Max. plus
50/56	-10.00	+7.25
55/61	-10.00	+7.25
60/66	-10.00	+6.75
65/71	-9.00	+6.25
70/76	-9.00	+5.75
73/79	-9.00	+5.75

Add. 0.75 - 3.50

LENS: **All digital progressive**
 INDEX: **1.67**
 MATERIAL: **PhotoViews**
 COLOURS: **Grey/Brown**

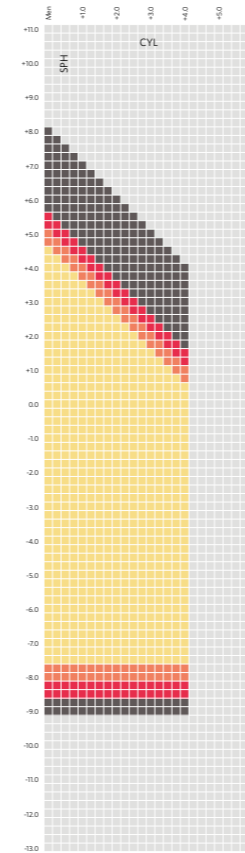

Dia.	Max. minus	Max. plus
50	-9.00	+8.00
55	-9.00	+8.00
60	-9.00	+8.00
65	-8.50	+5.50
70	-8.00	+5.00
75	-7.50	+4.50

Add. 0.75 - 3.50

LENS: **All digital progressive**
 INDEX: **1.67**
 MATERIAL:
 COLOURS:

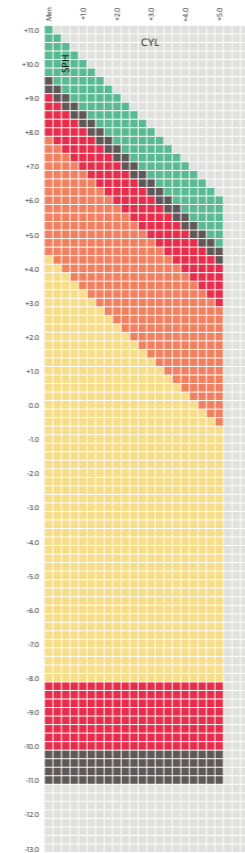

Dia.	Max. minus	Max. plus
50/56	-11.00	+11.00
55/61	-11.00	+11.00
60/66	-11.00	+9.50
65/71	-10.00	+9.00
70/76	-8.00	+7.75
75/81	-8.00	+4.25

Add. 0.75 - 3.50

LENS: **All digital progressive**
 INDEX: **1.67**
 MATERIAL: **Polarised**
 COLOURS: **Grey/Brown**

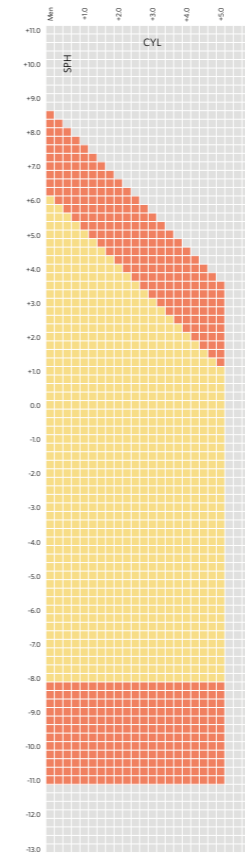

Dia.	Max. minus	Max. plus
50/56	-11.00	+8.50
55/61	-11.00	+8.50
60/66	-11.00	+8.50
65/71	-11.00	+8.50
70/76	-11.00	+8.50
76/82	-8.00	+6.00

Add. 0.75 - 3.50

LENS: **All digital progressive**
 INDEX: **1.67**
 MATERIAL: **Transitions®**
 COLOURS: **Green/Grey/Brown**

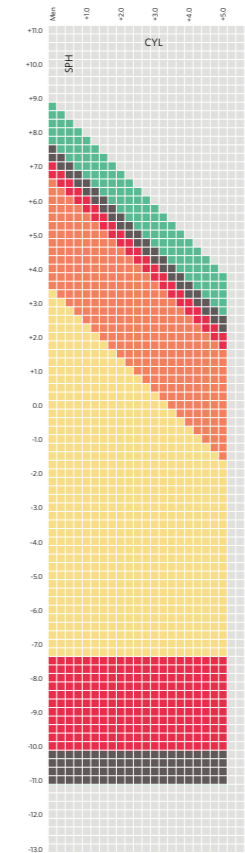

Dia.	Max. minus	Max. plus
50/56	-11.00	+8.75
55/61	-11.00	+8.75
60/66	-11.00	+7.50
65/71	-10.00	+7.00
70/76	-7.25	+6.50
76/82	-7.25	+3.25

Add. 0.75 - 3.50



DIGITAL PROGRESSIVE LENSES

LENS: **All digital progressive**
 INDEX: **1.67**
 MATERIAL: Transitions® XTRActive™
 COLOURS: Green/Grey/Brown

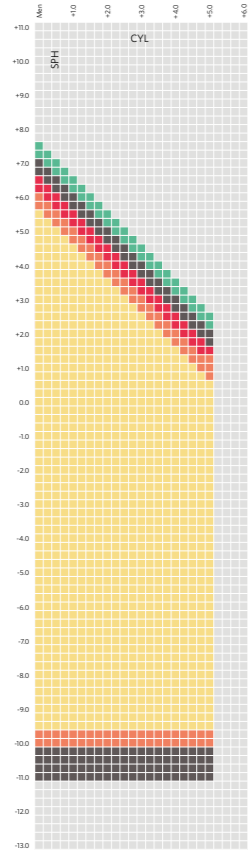

Dia.	Max. minus	Max. plus
50/56	-11.00	+7.50
55/61	-11.00	+7.50
60/66	-11.00	+7.00
65/71	-10.00	+6.50
70/76	-10.00	+6.00
74/80	-9.50	+5.50

Add. 0.75 - 3.50

LENS: **All digital progressive**
 INDEX: **1.74**
 MATERIAL:
 COLOURS:

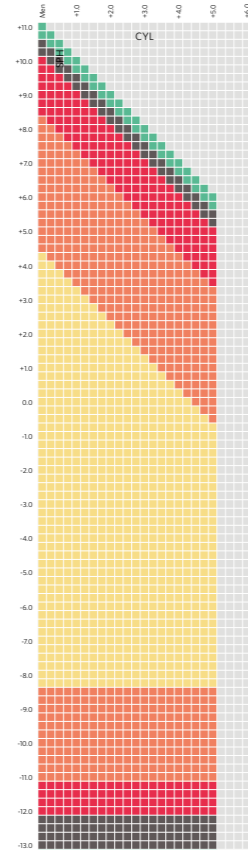

Dia.	Max. minus	Max. plus
50/56	-13.00	+11.00
55/61	-13.00	+11.00
60/66	-13.00	+10.50
65/71	-12.00	+10.00
70/76	-11.00	+8.25
75/81	-8.25	+4.25

Add. 0.75 - 3.50

LENS: **All digital progressive**
 INDEX: **1.74**
 MATERIAL: Transitions®
 COLOURS: Grey/Brown

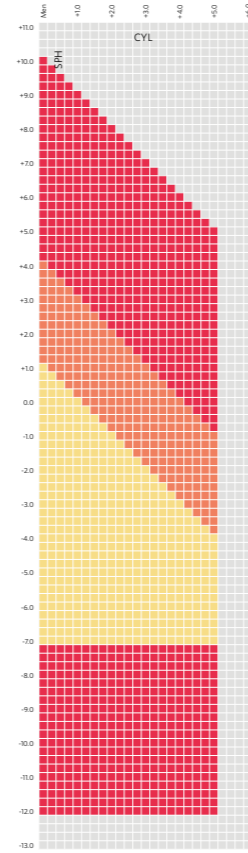

Dia.	Max. minus	Max. plus
50/56	-12.00	+10.00
55/61	-12.00	+10.00
60/66	-12.00	+10.00
65/71	-12.00	+10.50
70/76	-7.00	+4.00
74/80	-7.00	+1.00

Add. 0.75 - 3.50



OFFICE, HOBBY AND SPORT LENSES

LENS: **Anti-Fatigue**
 INDEX: **1.50**
 MATERIAL:
 COLOURS:

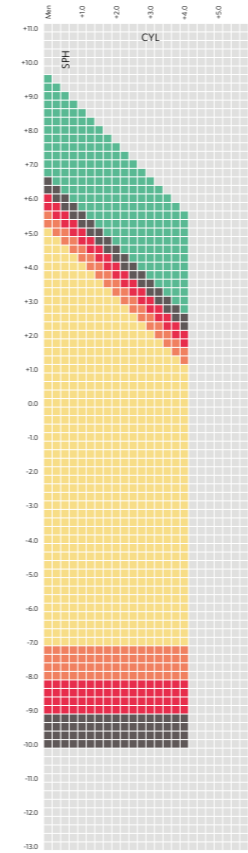

Dia.	Max. minus	Max. plus
50/56	-10.00	+9.50
55/61	-10.00	+9.50
60/66	-10.00	+6.50
65/71	-9.00	+6.00
70/76	-8.00	+5.50
75/81	-7.00	+5.00

LENS: **Anti-Fatigue**
 INDEX: **1.50**
 MATERIAL: Transitions®
 COLOURS: Green/Grey/Brown

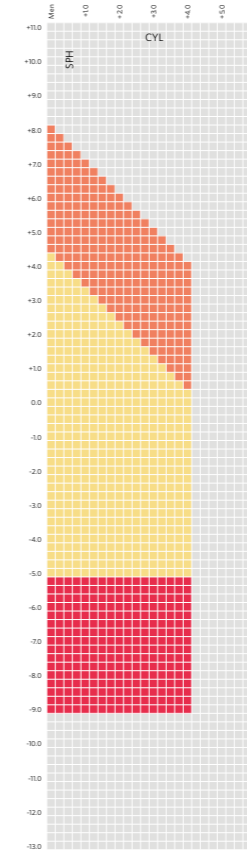

Dia.	Max. minus	Max. plus
50/56	-9.00	+8.00
55/61	-9.00	+8.00
60/66	-9.00	+8.00
65/71	-9.00	+8.00
70/76	-5.00	+8.00
76/82	-5.00	+4.25

LENS: **Anti-Fatigue**
 INDEX: **1.53**
 MATERIAL: Trivex
 COLOURS:

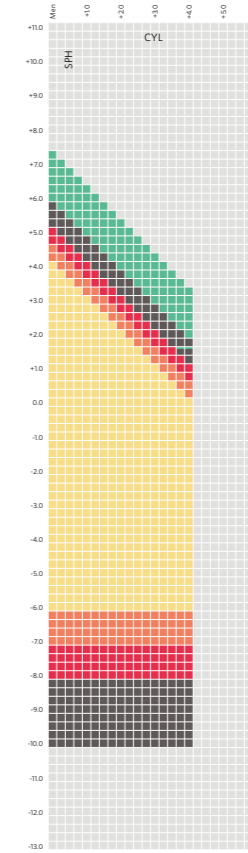

Dia.	Max. minus	Max. plus
50/56	-10.00	+7.25
55/61	-10.00	+7.25
60/66	-10.00	+5.75
65/71	-8.00	+5.00
70/76	-7.00	+4.50
75/81	-6.00	+4.00

LENS: **Anti-Fatigue**
 INDEX: **1.53**
 MATERIAL: Trivex Transitions®
 COLOURS: Grey/Brown

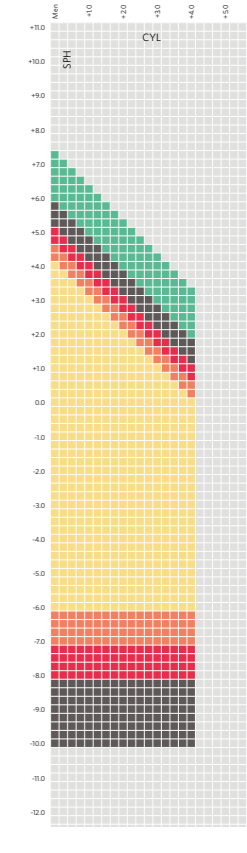

Dia.	Max. minus	Max. plus
50/56	-10.00	+7.25
55/61	-10.00	+7.25
60/66	-10.00	+5.75
65/71	-8.00	+5.00
70/76	-7.00	+4.50
75/81	-6.00	+4.00

OFFICE, HOBBY AND SPORT LENSES

LENS: **Anti-Fatigue**
 INDEX: **1.59**
 MATERIAL: Polycarbonate
 COLOURS:

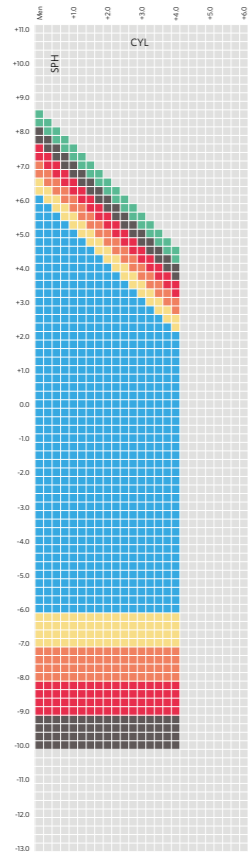

Dia.	Max. minus	Max. plus
50/56	-10.00	+8.50
55/61	-10.00	+8.50
60/66	-10.00	+8.00
65/71	-9.00	+7.50
70/76	-8.00	+7.00
75/81	-7.00	+6.50
80/86	-6.00	+6.00

LENS: **Anti-Fatigue**
 INDEX: **1.60**
 MATERIAL:
 COLOURS:

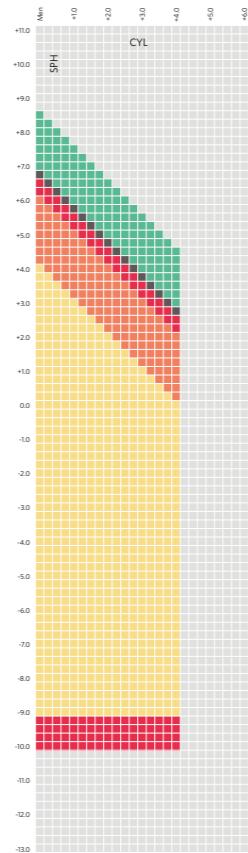

Dia.	Max. minus	Max. plus
50/56	-10.00	+8.50
55/61	-10.00	+8.50
60/66	-10.00	+6.75
65/71	-10.00	+6.50
70/76	-9.00	+6.00
75/81	-9.00	+4.00

LENS: **Anti-Fatigue**
 INDEX: **1.60**
 MATERIAL: Transitions®
 COLOURS: Green/Grey/Brown

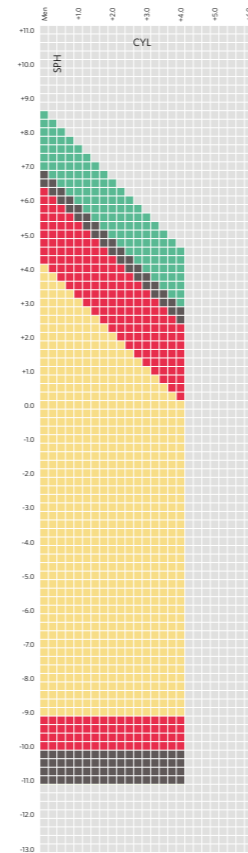

Dia.	Max. minus	Max. plus
50/56	-11.00	+8.50
55/61	-11.00	+8.50
60/66	-11.00	+6.75
65/71	-10.00	+6.25
70/76	-9.00	+4.00
75/81	-9.00	+4.00

LENS: **Anti-Fatigue**
 INDEX: **1.67**
 MATERIAL:
 COLOURS:

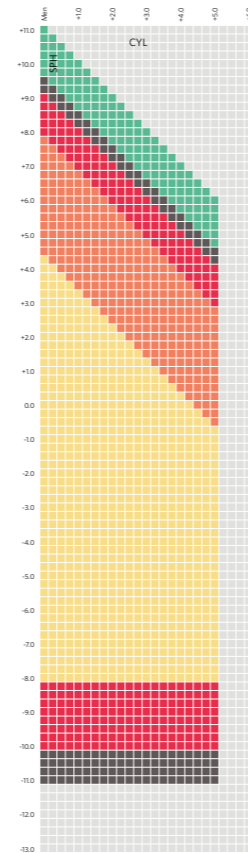

Dia.	Max. minus	Max. plus
50/56	-11.00	+11.00
55/61	-11.00	+11.00
60/66	-11.00	+9.50
65/71	-10.00	+9.00
70/76	-8.00	+7.75
75/81	-8.00	+4.25

LENS: **Anti-Fatigue**
 INDEX: **1.67**
 MATERIAL: Transitions®
 COLOURS: Green/Grey/Brown

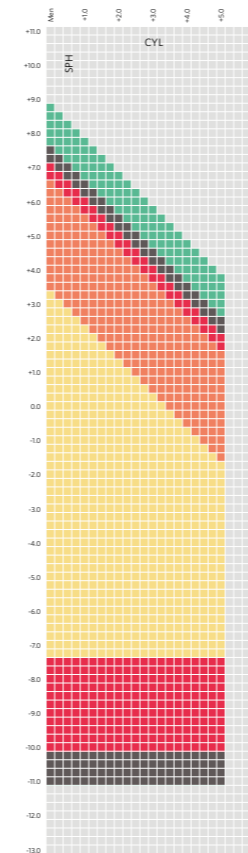

Dia.	Max. minus	Max. plus
50/56	-11.00	+8.75
55/61	-11.00	+8.75
60/66	-11.00	+7.50
65/71	-10.00	+7.00
70/76	-7.25	+6.50
76/82	-7.25	+3.25

LENS: **Anti-Fatigue**
 INDEX: **1.74**
 MATERIAL:
 COLOURS:

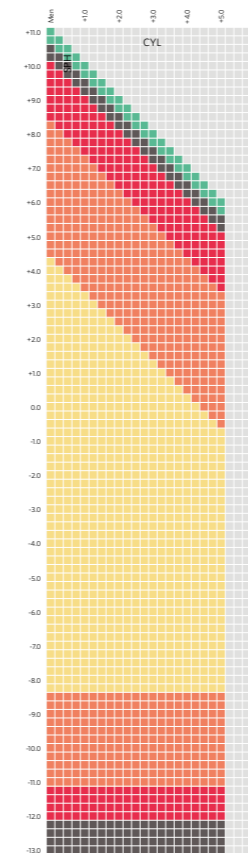

Dia.	Max. minus	Max. plus
50/56	-13.00	+11.00
55/61	-13.00	+11.00
60/66	-13.00	+10.50
65/71	-12.00	+10.00
70/76	-11.00	+8.25
75/81	-8.25	+4.25

LENS: **Softwear**
 INDEX: **1.50**
 MATERIAL:
 COLOURS:

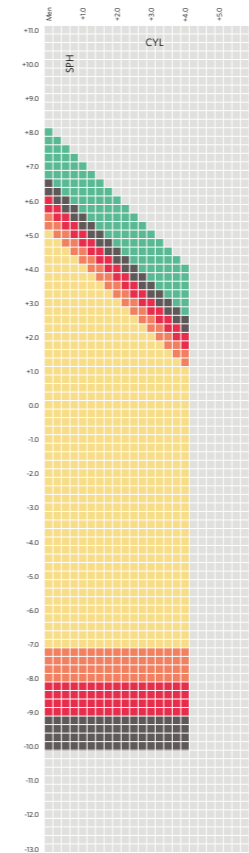

Dia.	Max. minus	Max. plus
50/56	-10.00	+8.00
55/61	-10.00	+8.00
60/66	-10.00	+6.50
65/71	-9.00	+6.00
70/76	-8.00	+5.50
75/81	-7.00	+5.00

Add. 0.75 - 3.50

LENS: **Softwear**
 INDEX: **1.60**
 MATERIAL:
 COLOURS:

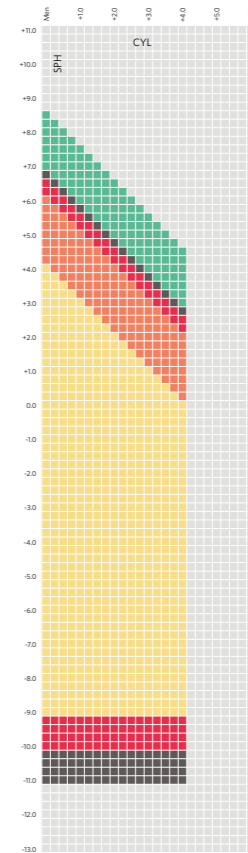

Dia.	Max. minus	Max. plus
50/56	-11.00	+8.50
55/61	-11.00	+8.50
60/66	-11.00	+6.75
65/71	-10.00	+6.50
70/76	-9.00	+6.00
75/81	-9.00	+4.00

Add. 0.75 - 3.50

LENS: **Softwear**
 INDEX: **1.67**
 MATERIAL:
 COLOURS:

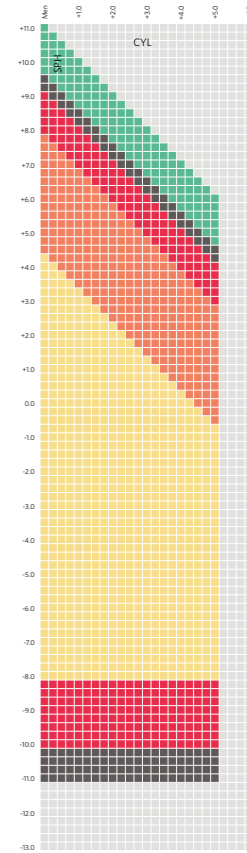

Dia.	Max. minus	Max. plus
50/56	-11.00	+11.00
55/61	-11.00	+11.00
60/66	-11.00	+9.50
65/71	-10.00	+9.00
70/76	-8.00	+7.75
75/81	-8.00	+4.25

Add. 0.75 - 3.50

OFFICE, HOBBY AND SPORT LENSES

LENS: **SolarTec**
 INDEX: **1.50 - 6 Base**
 MATERIAL:
 COLOURS:

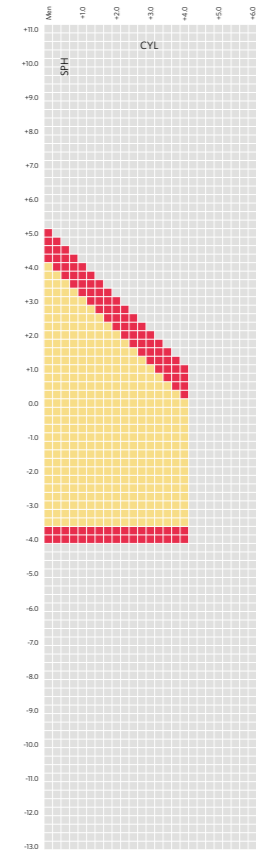

LENS: **SolarTec**
 INDEX: **1.50 - 8 Base**
 MATERIAL:
 COLOURS:

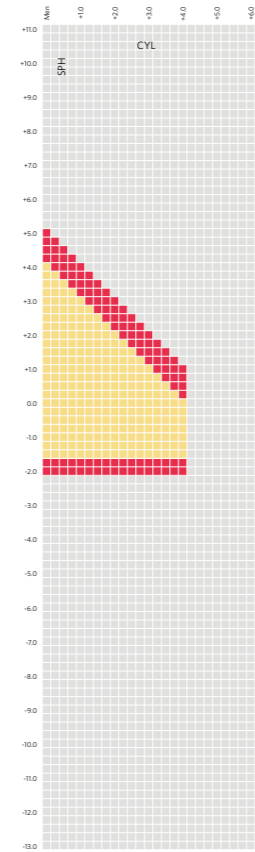

LENS: **SolarTec**
 INDEX: **1.50 - 6 Base**
 MATERIAL: **Polarised**
 COLOURS: **Grey/Brown**

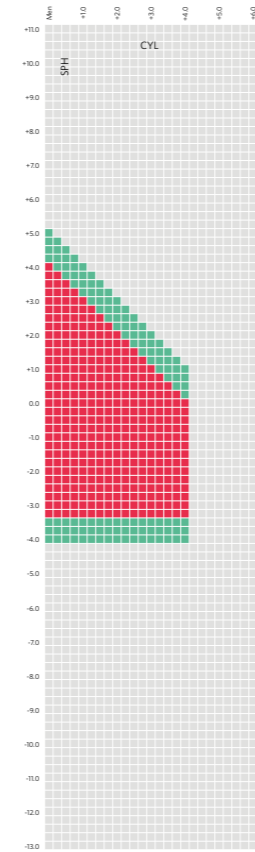

LENS: **SolarTec**
 INDEX: **1.50 - 8 Base**
 MATERIAL: **Polarised**
 COLOURS: **Grey/Brown**

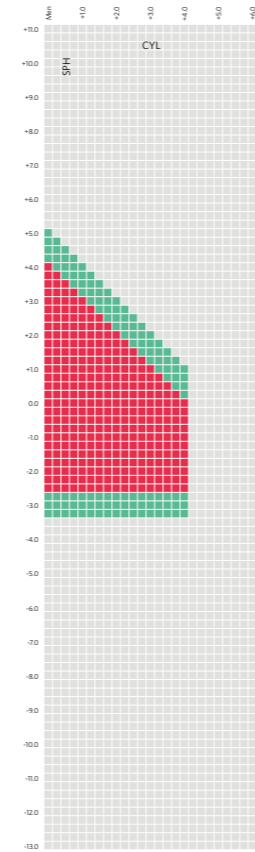

LENS: **SolarTec**
 INDEX: **1.50 - 6 Base**
 MATERIAL: **Transitions® XTRActive™**
 COLOURS: **Grey**

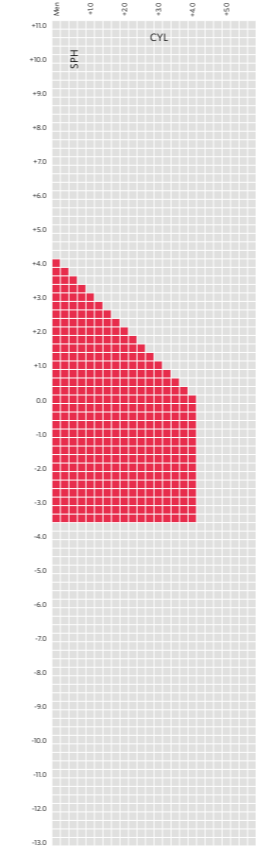

LENS: **SolarTec**
 INDEX: **1.50 - 8 Base**
 MATERIAL: **Transitions® XTRActive™**
 COLOURS: **Grey**

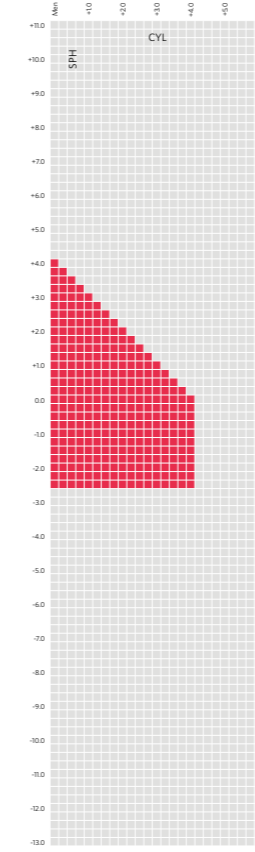

LENS: **SolarTec**
 INDEX: **1.50 - 6 Base**
 MATERIAL: **DriveWear**
 COLOURS:

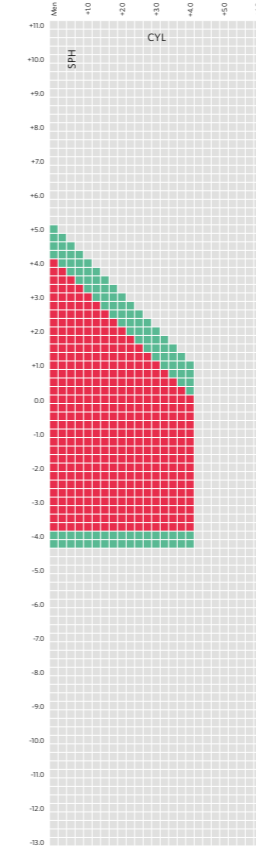

LENS: **SolarTec**
 INDEX: **1.50 - 8 Base**
 MATERIAL: **DriveWear**
 COLOURS:

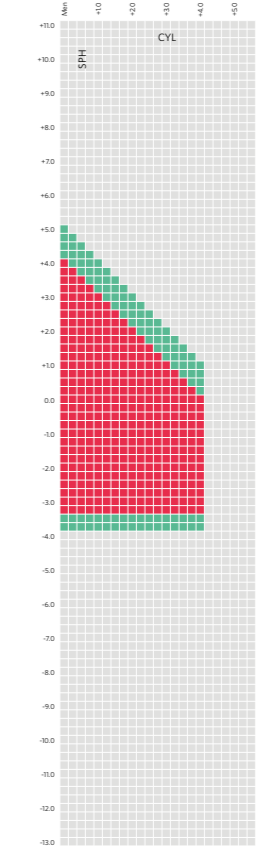

	Dia.	Max. minus	Max. plus
Single Vision	75/85	-4.00	+5.00
	80/90	-3.50	+4.00
Progressive	75/80	-4.00	+5.00
	80/85	-3.50	+4.00
Progressive - Add. 1.00 - 3.00			

	Dia.	Max. minus	Max. plus
Single Vision	75/85	-2.00	+5.00
	80/90	-1.50	+4.00
Progressive	75/80	-2.00	+5.00
	80/85	-1.50	+4.00
Progressive - Add. 1.00 - 3.00			

	Dia.	Max. minus	Max. plus
Single Vision	70/80	-4.00	+5.00
	75/85	-3.25	+4.00
Progressive	70/75	-4.00	+5.00
	75/80	-3.25	+4.00
Progressive - Add. 1.00 - 3.00			

	Dia.	Max. minus	Max. plus
Single Vision	70/80	-3.25	+5.00
	75/85	-2.50	+4.00
Progressive	70/75	-3.25	+5.00
	75/80	-2.50	+4.00
Progressive - Add. 1.00 - 3.00			

	Dia.	Max. minus	Max. plus
Single Vision	70/80	-3.50	+4.00
	75/85	-3.50	+4.00
Progressive	70/75	-3.50	+4.00
	75/80	-3.50	+4.00
Progressive - Add. 1.00 - 3.00			

	Dia.	Max. minus	Max. plus
Single Vision	70/75	-2.50	+4.00
	75/80	-2.50	+4.00
Progressive	70/75	-2.50	+4.00
	75/80	-2.50	+4.00
Progressive - Add. 1.00 - 3.00			

	Dia.	Max. minus	Max. plus
Single Vision	70/80	-4.25	+5.00
	74/84	-3.75	+4.00
Progressive	70/75	-4.25	+5.00
	74/79	-3.75	+4.00
Progressive - Add. 1.00 - 3.00			

	Dia.	Max. minus	Max. plus
Single Vision	70/80	-3.75	+5.00
	74/84	-3.25	+4.00
Progressive	70/75	-3.75	+5.00
	74/79	-3.25	+4.00
Progressive - Add. 1.00 - 3.00			



OFFICE, HOBBY AND SPORT LENSES

LENS: **SolarTec**
 INDEX: **1.60 - 6 Base**
 MATERIAL:
 COLOURS:

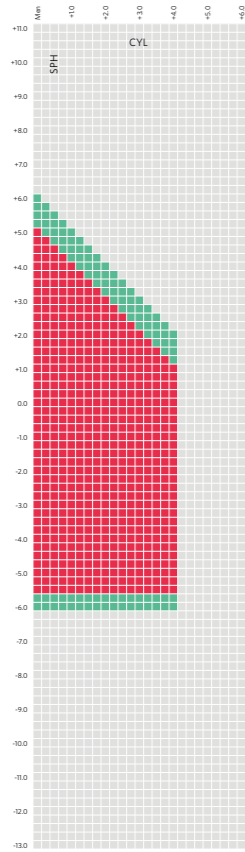

LENS: **SolarTec**
 INDEX: **1.60 - 8 Base**
 MATERIAL:
 COLOURS:

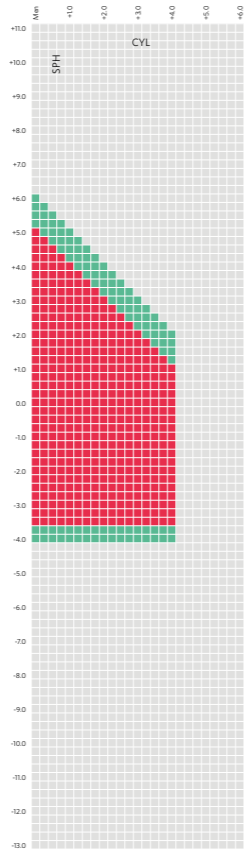

LENS: **SolarTec**
 INDEX: **1.60 - 6 Base**
 MATERIAL: Polarised
 COLOURS: Grey/Brown

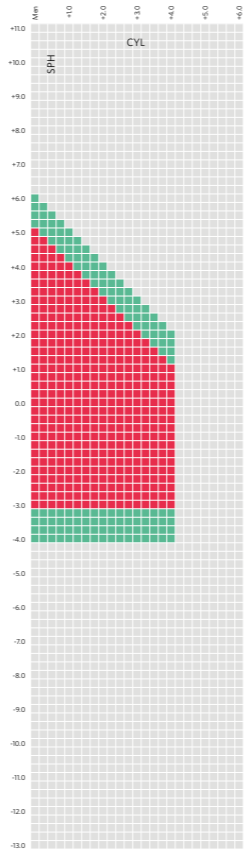

LENS: **SolarTec**
 INDEX: **1.60 - 8 Base**
 MATERIAL: Polarised
 COLOURS: Grey/Brown

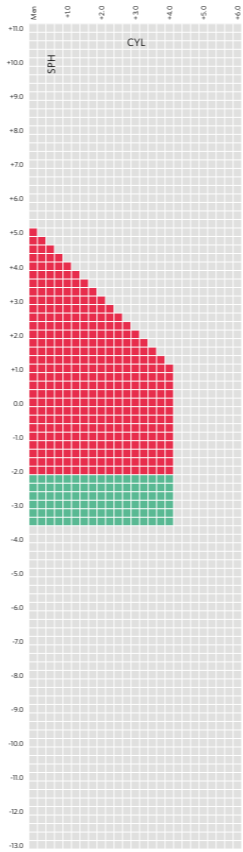

LENS: **SolarTec**
 INDEX: **1.60 - 6 Base**
 MATERIAL: Transitions® XTRActive™
 COLOURS: Grey

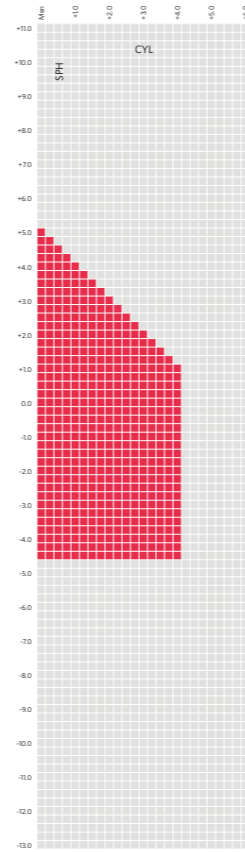

LENS: **SolarTec**
 INDEX: **1.60 - 8 Base**
 MATERIAL: Transitions® XTRActive™
 COLOURS: Grey

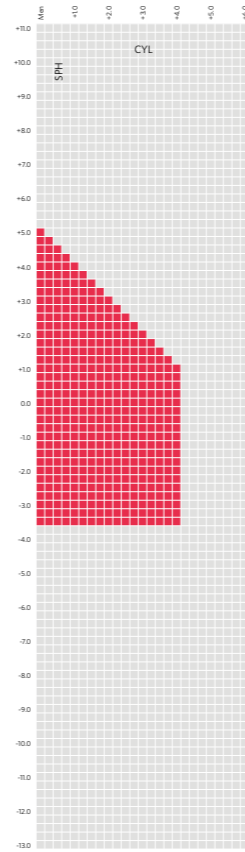

LENS: **SolarTec**
 INDEX: **1.67 - 6 Base**
 MATERIAL:
 COLOURS:

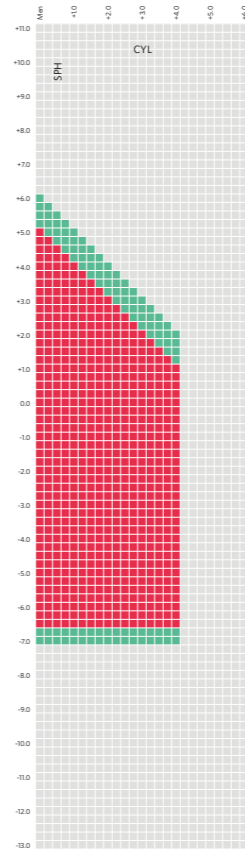

LENS: **SolarTec**
 INDEX: **1.67 - 8 Base**
 MATERIAL:
 COLOURS:

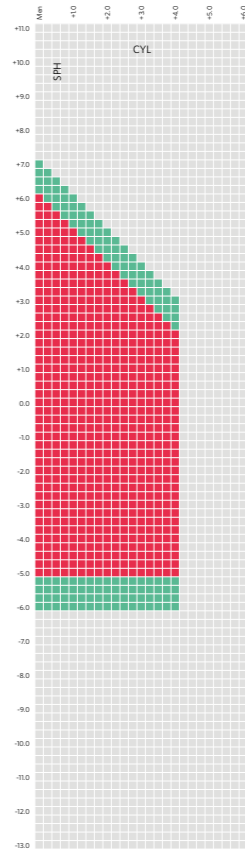

	Dia.	Max. minus	Max. plus
Single Vision	70/80	-6.00	+6.00
	75/80	-5.50	+5.00
Progressive	70/80	-6.00	+6.00
	75/80	-5.50	+5.00
	Progressive - Add. 1.00 - 3.00		

	Dia.	Max. minus	Max. plus
Single Vision	70/80	-4.00	+6.00
	75/80	-3.50	+5.00
Progressive	70/80	-4.00	+6.00
	75/80	-3.50	+5.00
	Progressive - Add. 1.00 - 3.00		

	Dia.	Max. minus	Max. plus
Single Vision	70/80	-4.00	+6.00
	75/85	-3.00	+5.00
Progressive	70/75	-4.00	+6.00
	75/80	-3.00	+5.00
	Progressive - Add. 1.00 - 3.00		

	Dia.	Max. minus	Max. plus
Single Vision	70/80	-3.50	+5.00
	75/85	-2.00	+5.00
Progressive	70/75	-3.50	+5.00
	75/80	-2.00	+5.00
	Progressive - Add. 1.00 - 3.00		

	Dia.	Max. minus	Max. plus
Single Vision	70/80	-4.50	+5.00
	73/83	-4.50	+5.00
Progressive	70/75	-4.50	+5.00
	73/83	-4.50	+5.00
	Progressive - Add. 1.00 - 3.00		

	Dia.	Max. minus	Max. plus
Single Vision	70/80	-3.50	+5.00
	73/83	-3.50	+5.00
Progressive	70/75	-3.50	+5.00
	73/83	-3.50	+5.00
	Progressive - Add. 1.00 - 3.00		

	Dia.	Max. minus	Max. plus
Single Vision	70/80	-7.00	+6.00
	75/85	-6.50	+5.00
Progressive	70/75	-7.00	+6.00
	75/80	-6.50	+5.00
	Progressive - Add. 1.00 - 3.00		

	Dia.	Max. minus	Max. plus
Single Vision	70/75	-6.00	+7.00
	75/80	-5.00	+6.00
Progressive	70/75	-6.00	+7.00
	75/80	-5.00	+6.00
	Progressive - Add. 1.00 - 3.00		



OFFICE, HOBBY AND SPORT LENSES

LENS: **SolarTec**
 INDEX: **1.67 - 6 Base**
 MATERIAL: Polarised
 COLOURS: Grey/Brown

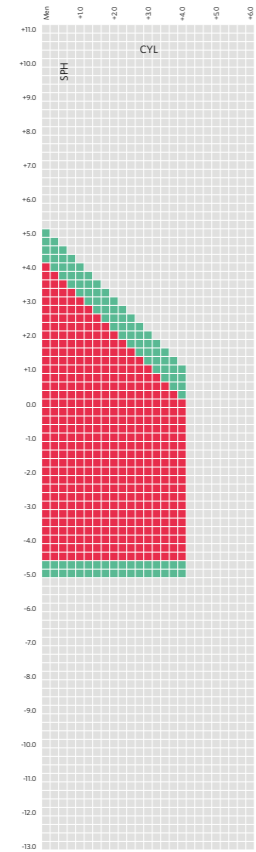

LENS: **SolarTec**
 INDEX: **1.67 - 8 Base**
 MATERIAL: Polarised
 COLOURS: Grey/Brown

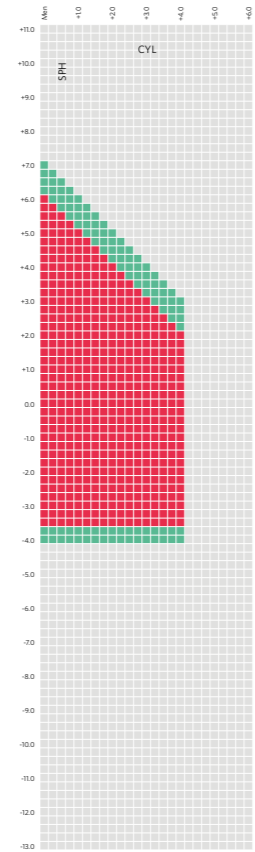

LENS: **SolarTec**
 INDEX: **1.67 - 6 Base**
 MATERIAL: Transitions® XTRActive™
 COLOURS: Grey

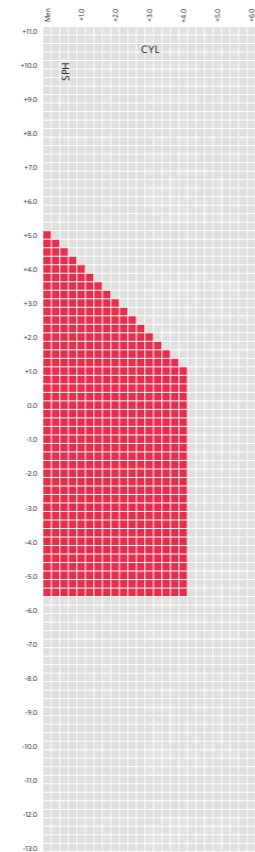

LENS: **SolarTec**
 INDEX: **1.67 - 8 Base**
 MATERIAL: Transitions® XTRActive™
 COLOURS: Grey

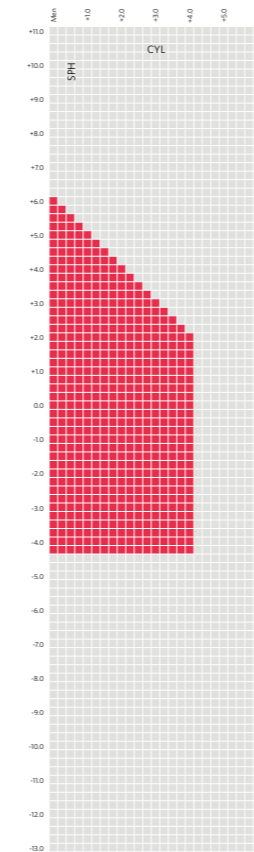

	Dia.	Max. minus	Max. plus
Single Vision	70/80	-5.00	+5.00
	75/85	-4.50	+4.00
Progressive	70/75	-5.00	+5.00
	75/80	-4.50	+4.00
Progressive - Add. 1.00 - 3.00			

	Dia.	Max. minus	Max. plus
Single Vision	70/80	-4.00	+7.00
	75/85	-3.50	+6.00
Progressive	70/75	-4.00	+7.00
	75/80	-3.50	+6.00
Progressive - Add. 1.00 - 3.00			

	Dia.	Max. minus	Max. plus
Single Vision	70/80	-5.50	+5.00
	74/84	-5.50	+5.00
Progressive	70/75	-5.50	+5.00
	74/79	-5.50	+5.00
Progressive - Add. 1.00 - 3.00			

	Dia.	Max. minus	Max. plus
Single Vision	70/80	-4.25	+6.00
	74/84	-4.25	+6.00
Progressive	70/75	-4.25	+6.00
	74/79	-4.25	+6.00
Progressive - Add. 1.00 - 3.00			

TRADITIONAL PROGRESSIVE LENSES

LENS: **Concise**
 INDEX: **1.50**
 MATERIAL:
 COLOURS:

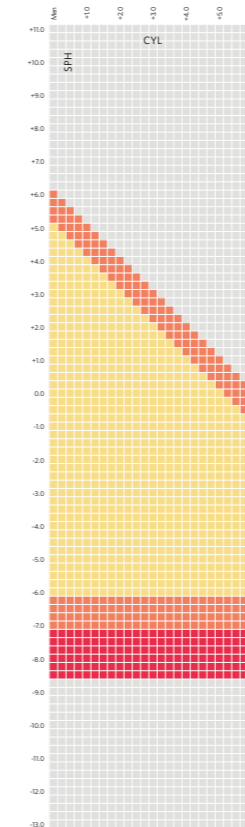

	Dia.	Max. minus	Max. plus
	50/56	-8.50	+6.00
	55/61	-8.50	+6.00
	60/66	-8.50	+6.00
	65/71	-8.50	+6.00
	70/76	-7.00	+6.00
	74/80	-7.00	+6.00
Add. 1.00 - 3.00			

LENS: **Concise**
 INDEX: **1.59**
 MATERIAL: Polycarbonate
 COLOURS:

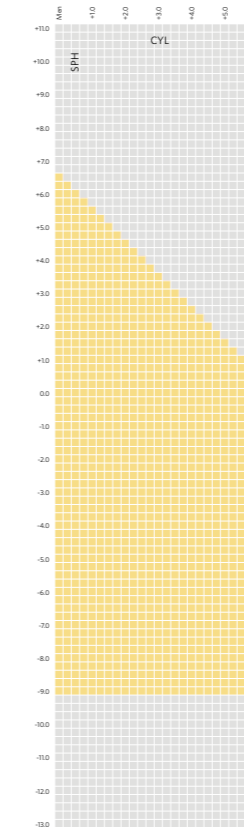

	Dia.	Max. minus	Max. plus
	50/56	-9.00	+6.50
	55/61	-9.00	+6.50
	60/66	-9.00	+6.50
	65/71	-9.00	+6.50
	70/76	-9.00	+6.50
	78/84	-9.00	+6.50
Add. 1.00 - 3.00			

LENS: **Concise**
 INDEX: **1.60**
 MATERIAL:
 COLOURS:

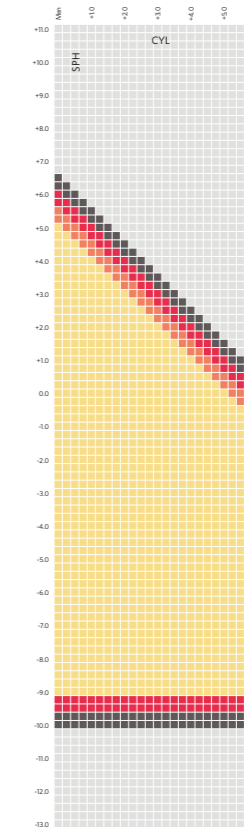

	Dia.	Max. minus	Max. plus
	50/56	-10.00	+6.50
	55/61	-10.00	+6.50
	60/66	-10.00	+6.50
	65/71	-9.50	+6.00
	70/76	-9.00	+5.50
	78/84	-9.00	+5.00
Add. 1.00 - 3.00			

LENS: **Concise**
 INDEX: **1.67**
 MATERIAL:
 COLOURS:

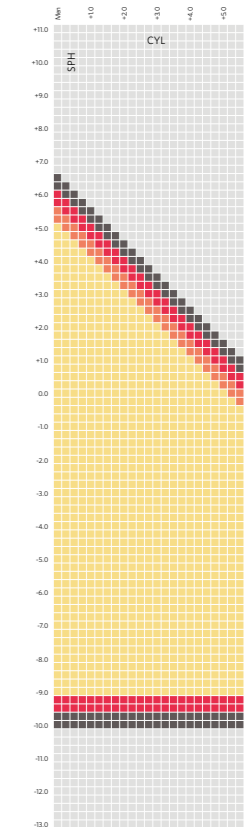

	Dia.	Max. minus	Max. plus
	50/56	-10.00	+6.50
	55/61	-10.00	+6.50
	60/66	-10.00	+6.50
	65/71	-9.50	+6.00
	70/76	-9.00	+5.50
	78/84	-9.00	+5.00
Add. 1.00 - 3.00			

TRADITIONAL PROGRESSIVE LENSES

LENS: **Precise**
 INDEX: **1.50**
 MATERIAL:
 COLOURS:

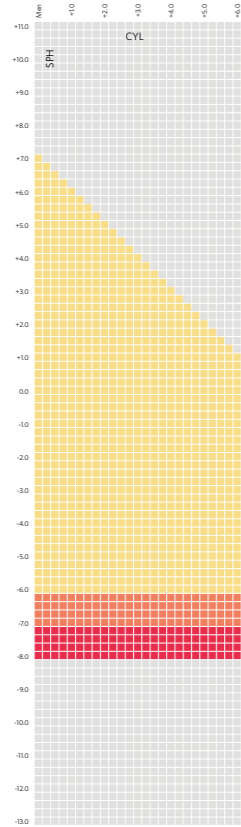

Dia.	Max. minus	Max. plus
50/56	-8.00	+7.00
55/61	-8.00	+7.00
60/66	-8.00	+7.00
65/71	-8.00	+7.00
70/76	-7.00	+7.00
74/80	-6.00	+7.00

Add. 1.00 - 3.00

LENS: **Precise**
 INDEX: **1.50**
 MATERIAL: **Polarised**
 COLOURS: **Grey/Brown**

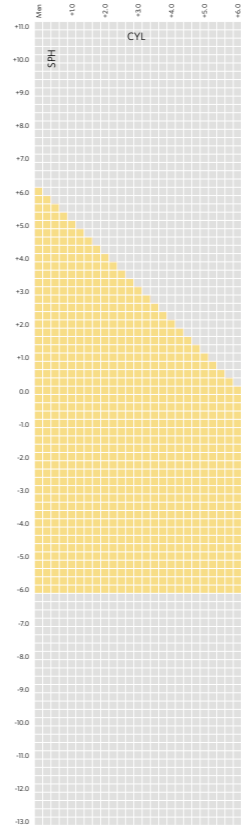

Dia.	Max. minus	Max. plus
50/56	-6.00	+6.00
55/61	-6.00	+6.00
60/66	-6.00	+6.00
65/71	-6.00	+6.00
70/76	-6.00	+6.00
78/84	-6.00	+6.00

Add. 1.00 - 3.00

LENS: **Precise**
 INDEX: **1.59**
 MATERIAL: **Polycarbonate**
 COLOURS:

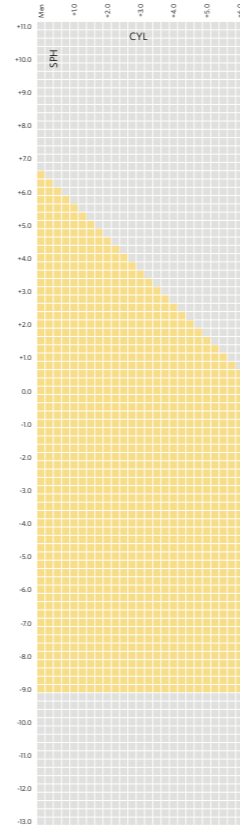

Dia.	Max. minus	Max. plus
50/56	-9.00	+6.50
55/61	-9.00	+6.50
60/66	-9.00	+6.50
65/71	-9.00	+6.50
70/76	-9.00	+6.50
78/84	-9.00	+6.50

Add. 1.00 - 3.00

LENS: **Precise**
 INDEX: **1.60**
 MATERIAL:
 COLOURS:

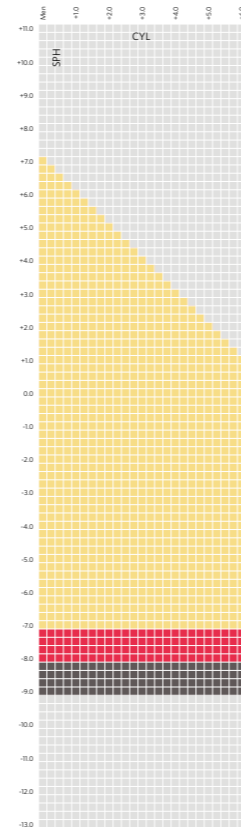

Dia.	Max. minus	Max. plus
50/56	-9.00	+7.00
55/61	-9.00	+7.00
60/66	-9.00	+7.00
65/71	-8.00	+7.00
70/76	-7.00	+7.00
78/84	-7.00	+7.00

Add. 1.00 - 3.00

LENS: **Precise**
 INDEX: **1.67**
 MATERIAL:
 COLOURS:

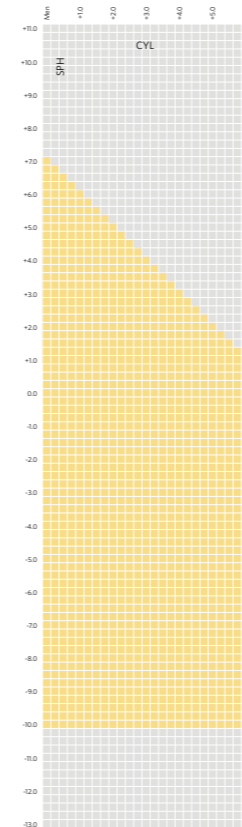

Dia.	Max. minus	Max. plus
50/56	-10.00	+7.00
55/61	-10.00	+7.00
60/66	-10.00	+7.00
65/71	-10.00	+7.00
70/76	-10.00	+7.00
78/84	-10.00	+7.00

Add. 1.00 - 3.00



TRADITIONAL BIFOCAL LENSES

LENS: **FT28**
 INDEX: **1.50**
 MATERIAL:
 COLOURS:

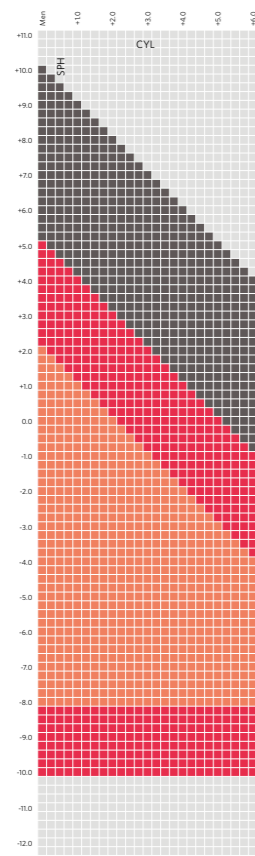

Dia.	Max. minus	Max. plus
50	-10.00	+10.00
55	-10.00	+10.00
60	-10.00	+10.00
65	-10.00	+5.00
70	-8.00	+2.00

Add. 0.75 - 3.50

LENS: **FT28**
 INDEX: **1.50**
 MATERIAL: **Polarised**
 COLOURS: **Grey/Brown**

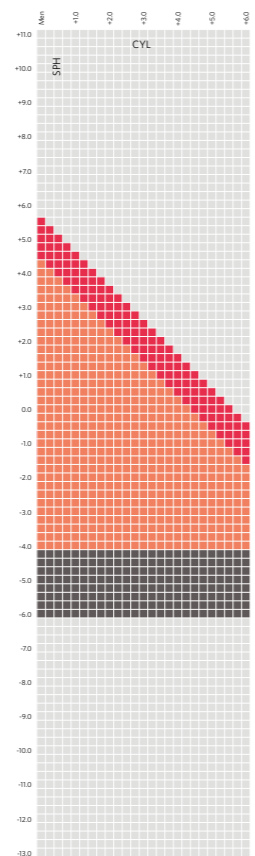

Dia.	Max. minus	Max. plus
50	-6.00	+5.50
55	-6.00	+5.50
60	-6.00	+5.50
65	-4.00	+5.50
70	-4.00	+4.25

Add. 1.00 - 3.50

LENS: **FT28**
 INDEX: **1.50**
 MATERIAL: **Transitions®**
 COLOURS: **Grey/Brown**

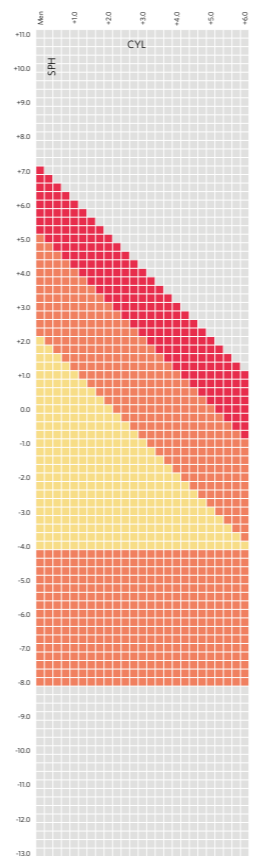

Dia.	Max. minus	Max. plus
50	-8.00	+7.00
55	-8.00	+7.00
60	-8.00	+7.00
65	-8.00	+7.00
70	-8.00	+5.00
76	-4.00	+2.00

Add. 1.00 - 3.00

LENS: **FT28**
 INDEX: **1.60**
 MATERIAL:
 COLOURS:

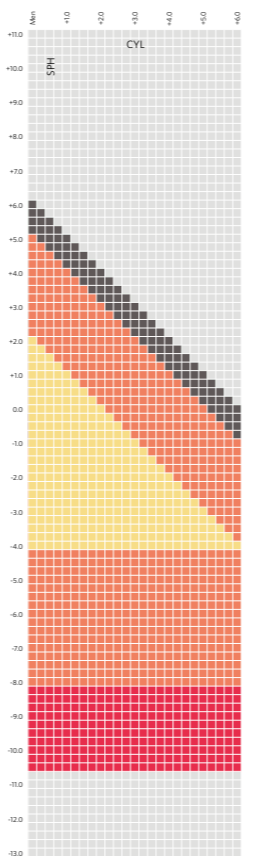

Dia.	Max. minus	Max. plus
50	-10.50	+6.00
55	-10.50	+6.00
60	-10.50	+6.00
65	-10.50	+5.00
70	-8.00	+5.00
75	-4.00	+2.00

Add. 1.00 - 3.00

LENS: **FT28**
 INDEX: **1.67**
 MATERIAL:
 COLOURS:

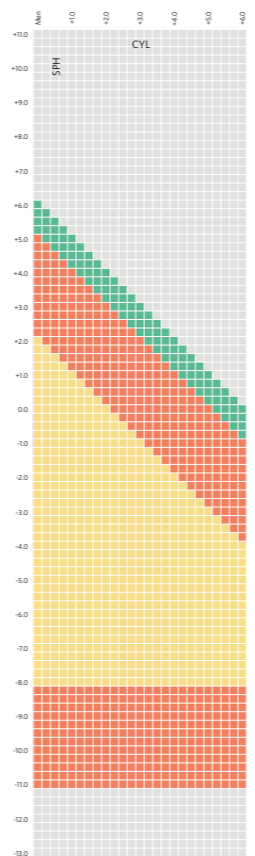

Dia.	Max. minus	Max. plus
50	-11.00	+6.00
55	-11.00	+6.00
60	-11.00	+5.00
65	-11.00	+5.00
70	-11.00	+5.00
75	-8.00	+2.00

Add. 1.00 - 3.00

LENS: **FT28**
 INDEX: **1.59**
 MATERIAL: **Polycarbonate**
 COLOURS:

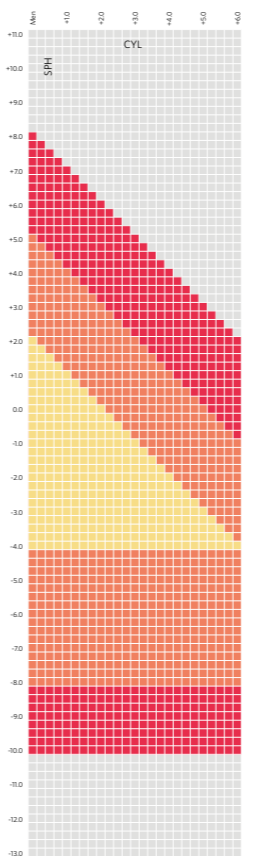

Dia.	Max. minus	Max. plus
50	-10.00	+8.00
55	-10.00	+8.00
60	-10.00	+8.00
65	-10.00	+8.00
70	-8.00	+5.00
75	-4.00	+2.00

Add. 1.00 - 3.00

LENS: **CT28**
 INDEX: **1.60**
 MATERIAL:
 COLOURS:

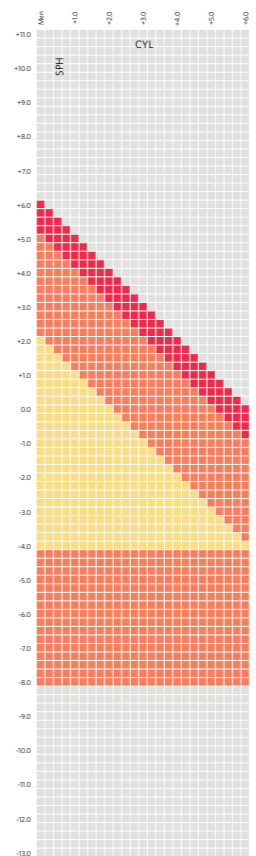

Dia.	Max. minus	Max. plus
50	-8.00	+6.00
55	-8.00	+6.00
60	-8.00	+6.00
65	-8.00	+6.00
70	-8.00	+5.00
75	-4.00	+2.00

Add. 1.00 - 3.50



DIGITAL SINGLE VISION LENSES

LENS: **Digital Single Vision**
 INDEX: **1.50**
 MATERIAL:
 COLOURS:

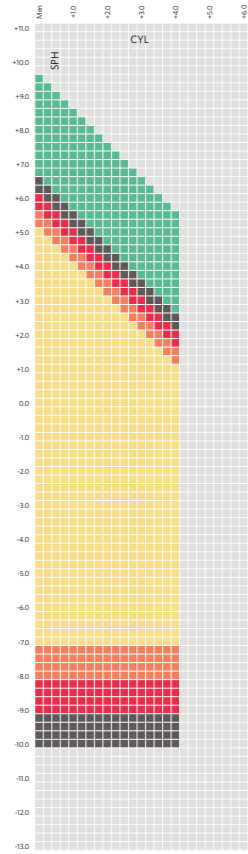

Dia.	Max. minus	Max. plus
50/56	-10.00	+9.50
55/61	-10.00	+9.50
60/66	-10.00	+6.50
65/71	-9.00	+6.00
70/76	-8.00	+5.50
75/81	-7.00	+5.00

LENS: **Digital Single Vision**
 INDEX: **1.50**
 MATERIAL: PhotoViews
 COLOURS: Grey/Brown

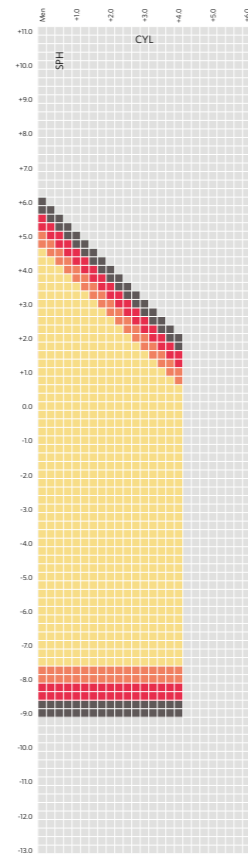

Dia.	Max. minus	Max. plus
50/56	-9.00	+6.00
55/61	-9.00	+6.00
60/66	-9.00	+6.00
65/71	-8.50	+5.50
70/76	-8.00	+5.00
75/81	-7.50	+4.50

LENS: **Digital Single Vision**
 INDEX: **1.50**
 MATERIAL: Polarised
 COLOURS: Green/Grey/Brown

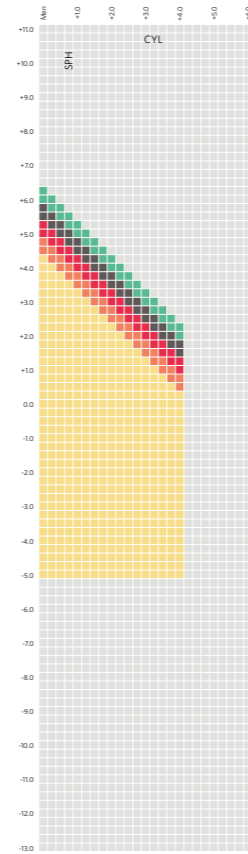

Dia.	Max. minus	Max. plus
50/56	-5.00	+6.25
55/61	-5.00	+6.25
60/66	-5.00	+5.75
65/71	-5.00	+5.25
70/76	-5.00	+4.75
76/82	-5.00	+4.25

LENS: **Digital Single Vision**
 INDEX: **1.50**
 MATERIAL: Transitions®
 COLOURS: Green/Grey/Brown

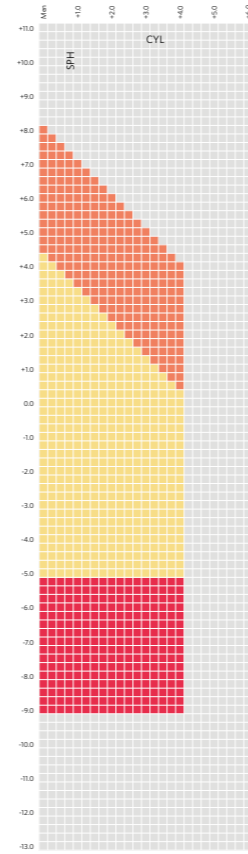

Dia.	Max. minus	Max. plus
50/56	-9.00	+8.00
55/61	-9.00	+8.00
60/66	-9.00	+8.00
65/71	-9.00	+8.00
70/76	-5.00	+8.00
76/82	-5.00	+4.25

LENS: **Digital Single Vision**
 INDEX: **1.50**
 MATERIAL: Transitions® XTRActive™
 COLOURS: Green/Grey/Brown

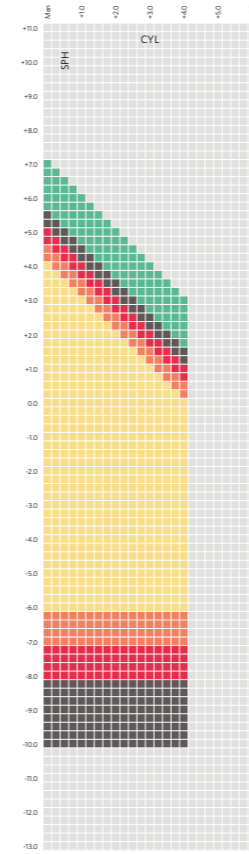

Dia.	Max. minus	Max. plus
50/56	-10.00	+7.00
55/61	-10.00	+7.00
60/66	-10.00	+5.50
65/71	-8.00	+5.00
70/76	-7.00	+4.50
76/82	-6.00	+4.00

LENS: **Digital Single Vision**
 INDEX: **1.53**
 MATERIAL: Trivex
 COLOURS:

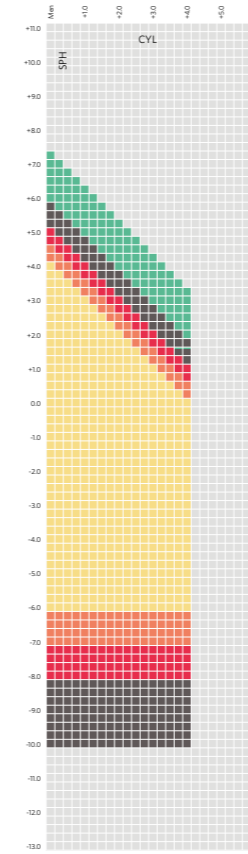

Dia.	Max. minus	Max. plus
50/56	-10.00	+7.25
55/61	-10.00	+7.25
60/66	-10.00	+5.75
65/71	-8.00	+5.00
70/76	-7.00	+4.50
75/81	-6.00	+4.00

LENS: **Digital Single Vision**
 INDEX: **1.53**
 MATERIAL: Trivex Transitions®
 COLOURS: Grey/Brown

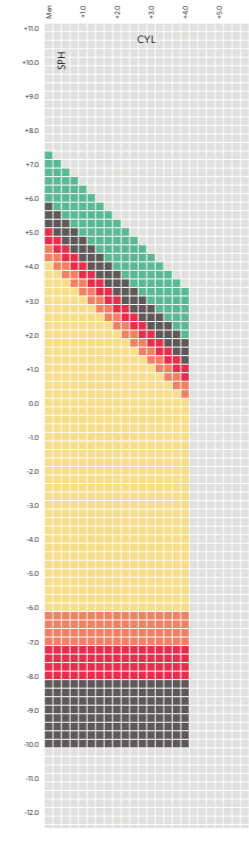

Dia.	Max. minus	Max. plus
50/56	-10.00	+7.25
55/61	-10.00	+7.25
60/66	-10.00	+5.75
65/71	-8.00	+5.00
70/76	-7.00	+4.50
75/81	-6.00	+4.00

LENS: **Digital Single Vision**
 INDEX: **1.60**
 MATERIAL:
 COLOURS:

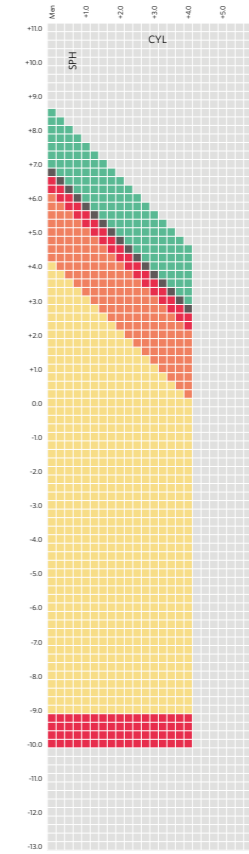

Dia.	Max. minus	Max. plus
50/56	-10.00	+8.50
55/61	-10.00	+8.50
60/66	-10.00	+6.75
65/71	-10.00	+6.50
70/76	-9.00	+6.00
75/81	-9.00	+4.00



DIGITAL SINGLE VISION LENSES

LENS: **Digital Single Vision**
 INDEX: **1.60**
 MATERIAL: PhotoViews
 COLOURS: Grey/Brown

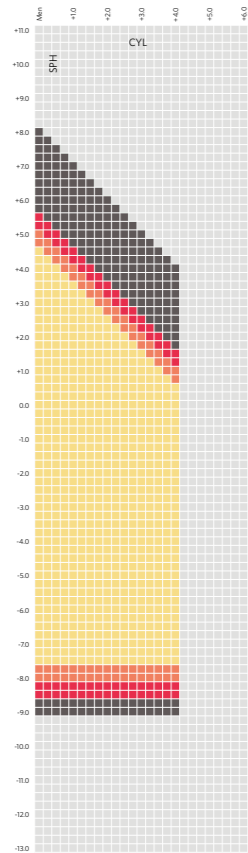

Dia.	Max. minus	Max. plus
50/56	-9.00	+8.00
55/61	-9.00	+8.00
60/66	-9.00	+8.00
65/71	-8.50	+5.50
70/76	-8.00	+5.00
75/81	-7.50	+4.50

LENS: **Digital Single Vision**
 INDEX: **1.60**
 MATERIAL: Polarised
 COLOURS: Green/Grey/Brown

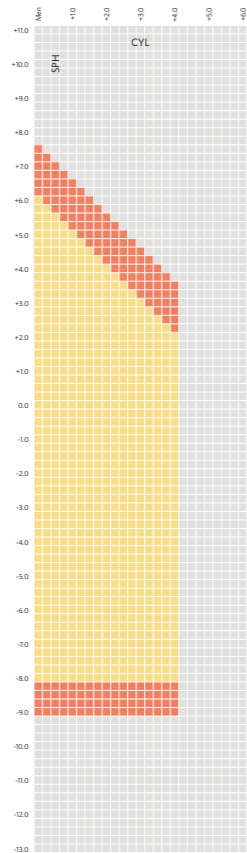

Dia.	Max. minus	Max. plus
50/56	-9.00	+7.50
55/61	-9.00	+7.50
60/66	-9.00	+7.50
65/71	-9.00	+7.50
70/76	-9.00	+7.50
76/82	-8.00	+6.00

LENS: **Digital Single Vision**
 INDEX: **1.60**
 MATERIAL: Transitions®
 COLOURS: Green/Grey/Brown

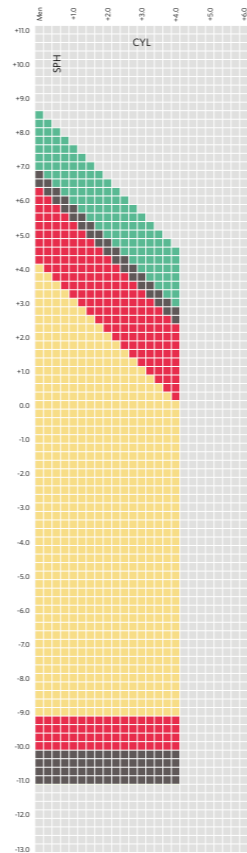

Dia.	Max. minus	Max. plus
50/56	-11.00	+8.50
55/61	-11.00	+8.50
60/66	-11.00	+6.75
65/71	-10.00	+6.25
70/76	-9.00	+4.00
75/81	-9.00	+4.00

LENS: **Digital Single Vision**
 INDEX: **1.60**
 MATERIAL: Transitions® XTRActive™
 COLOURS: Green/Grey/Brown

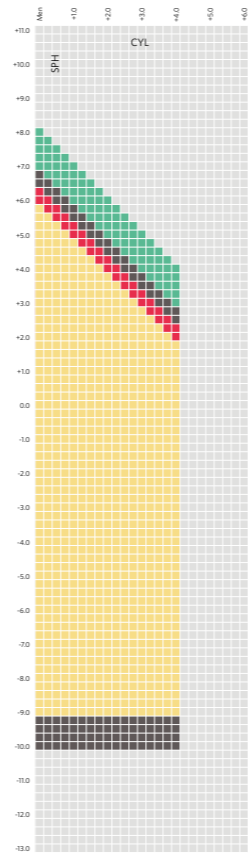

Dia.	Max. minus	Max. plus
50/56	-10.00	+8.00
55/61	-10.00	+8.00
60/66	-10.00	+6.75
65/71	-9.00	+6.00
70/76	-9.00	+5.75
73/79	-9.00	+5.75

LENS: **Digital Single Vision**
 INDEX: **1.67**
 MATERIAL: Polarised
 COLOURS:

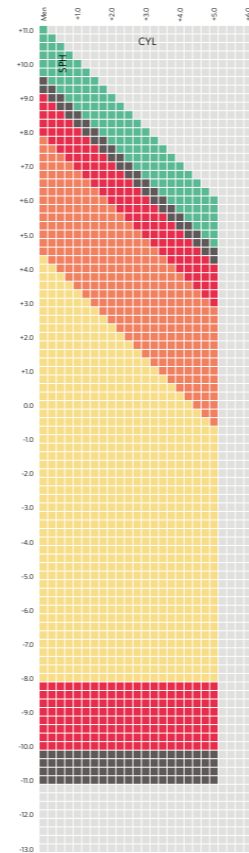

Dia.	Max. minus	Max. plus
50/56	-11.00	+11.00
55/61	-11.00	+11.00
60/66	-11.00	+9.50
65/71	-10.00	+9.00
70/76	-8.00	+7.75
75/81	-8.00	+4.25

LENS: **Digital Single Vision**
 INDEX: **1.67**
 MATERIAL: Polarised
 COLOURS: Grey/Brown

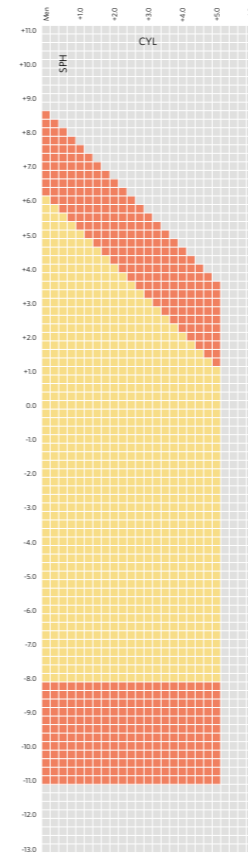

Dia.	Max. minus	Max. plus
50/56	-11.00	+8.50
55/61	-11.00	+8.50
60/66	-11.00	+8.50
65/71	-11.00	+8.50
70/76	-11.00	+8.50
76/82	-8.00	+6.00

LENS: **Digital Single Vision**
 INDEX: **1.67**
 MATERIAL: Polarised
 COLOURS: Green/Grey/Brown

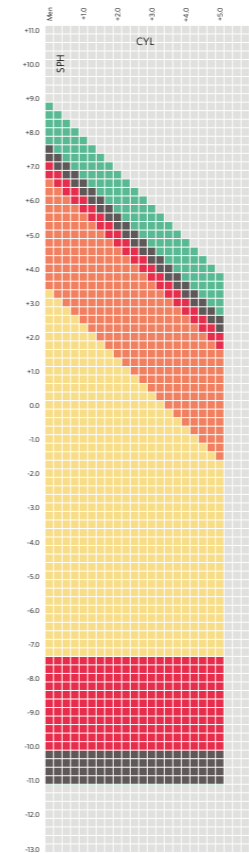

Dia.	Max. minus	Max. plus
50/56	-11.00	+8.75
55/61	-11.00	+8.75
60/66	-11.00	+7.50
65/71	-10.00	+7.00
70/76	-7.25	+6.50
76/82	-7.25	+3.25

LENS: **Digital Single Vision**
 INDEX: **1.67**
 MATERIAL: Transitions® XTRActive™
 COLOURS: Green/Grey/Brown

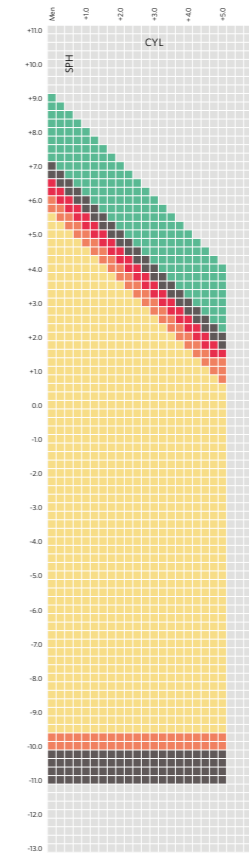

Dia.	Max. minus	Max. plus
50/56	-11.00	+9.00
55/61	-11.00	+9.00
60/66	-11.00	+7.00
65/71	-10.00	+6.50
70/76	-10.00	+6.00
74/80	-9.50	+5.50



DIGITAL SINGLE VISION LENSES

LENS: **Digital Single Vision**
 INDEX: **1.74**
 MATERIAL: **Transitions®**
 COLOURS:

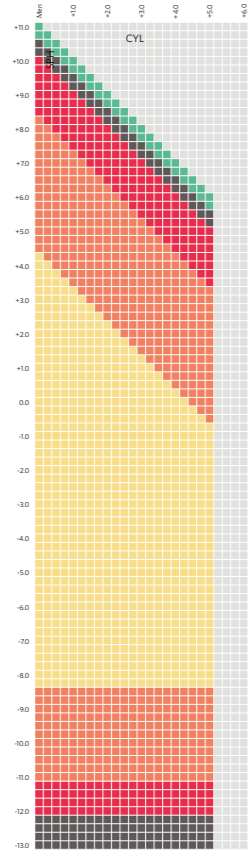

Dia.	Max. minus	Max. plus
50/56	-13.00	+11.00
55/61	-13.00	+11.00
60/66	-13.00	+10.50
65/71	-12.00	+10.00
70/76	-11.00	+8.25
75/81	-8.25	+4.25

LENS: **Digital Single Vision**
 INDEX: **1.74**
 MATERIAL: **Transitions®**
 COLOURS: **Grey/Brown**

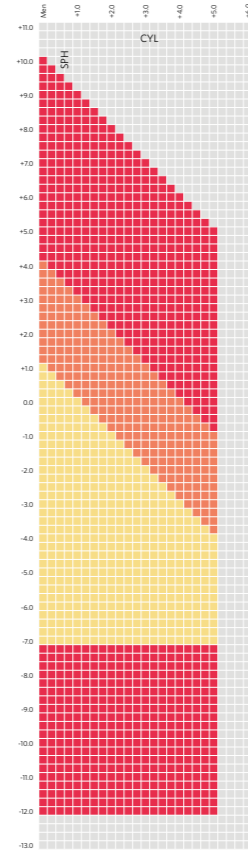

Dia.	Max. minus	Max. plus
50/56	-12.00	+10.00
55/61	-12.00	+10.00
60/66	-12.00	+10.00
65/71	-12.00	+10.50
70/76	-7.00	+4.00
74/80	-7.00	+1.00

CONVENTIONAL SINGLE VISION LENSES

LENS: **Single Vision**
 INDEX: **1.50 Aspheric**
 MATERIAL:
 COLOURS:

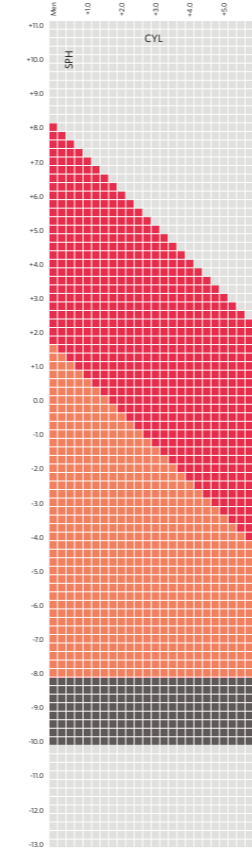

Dia.	Max. minus	Max. plus
50	-10.00	+8.00
55	-10.00	+8.00
60	-10.00	+8.00
65	-8.00	+8.00
70	-8.00	+1.50

LENS: **Single Vision**
 INDEX: **1.50**
 MATERIAL: **Polarised**
 COLOURS: **Grey/Brown**

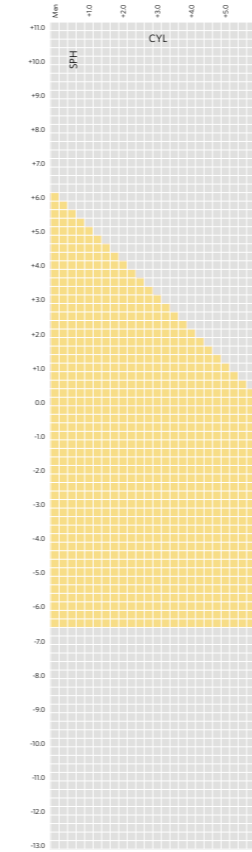

Dia.	Max. minus	Max. plus
50	-6.50	+6.00
55	-6.50	+6.00
60	-6.50	+6.00
65	-6.50	+6.00
70	-6.50	+6.00
75	-6.50	+6.00

LENS: **Single Vision**
 INDEX: **1.50**
 MATERIAL: **Transitions®**
 COLOURS: **Green*/Grey/Brown**

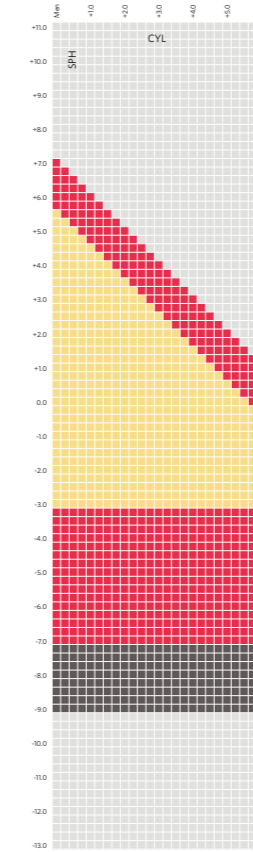

Dia.	Max. minus	Max. plus
50	-9.00	+7.00
55	-9.00	+7.00
60	-9.00	+7.00
65	-9.00	+7.00
70	-3.00	+5.50
72	-3.00	+5.50

LENS: **Single Vision**
 INDEX: **1.59**
 MATERIAL: **Polycarbonate**
 COLOURS:

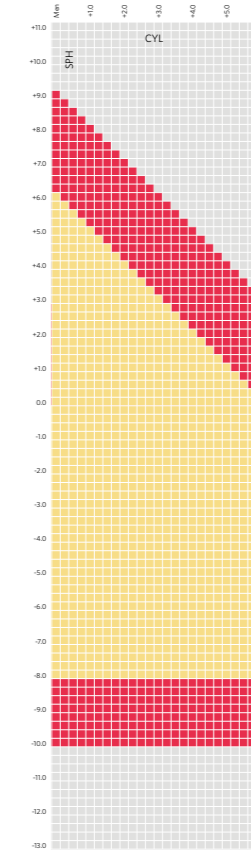

Dia.	Max. minus	Max. plus
50	-10.00	+9.00
55	-10.00	+9.00
60	-10.00	+9.00
65	-10.00	+9.00
70	-8.00	+6.00
72	-8.00	+6.00

LENS: **Single Vision**
 INDEX: **1.60 Aspheric**
 MATERIAL:
 COLOURS:

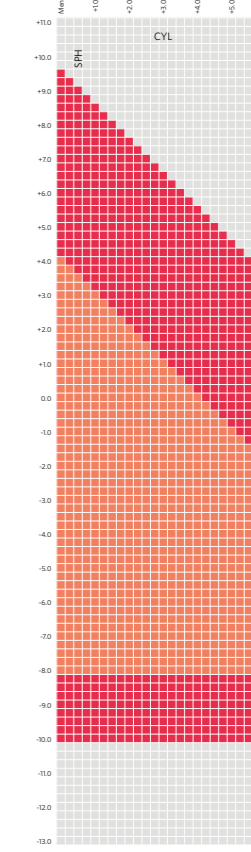

Dia.	Max. minus	Max. plus
50	-10.00	+9.50
55	-10.00	+9.50
60	-10.00	+9.50
65	-10.00	+9.50
70	-8.00	+4.00

CONVENTIONAL SINGLE VISION LENSES

LENS: **Single Vision**
 INDEX: **1.60**
 MATERIAL: Transitions®
 COLOURS: Green*/Grey/Brown

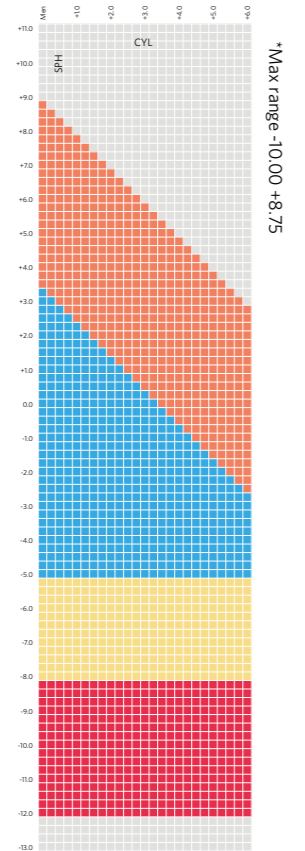

Dia.	Max. minus	Max. plus
50	-12.00	+8.75
55	-12.00	+8.75
60	-12.00	+8.75
65	-12.00	+8.75
70	-8.00	+8.75
75	-8.00	+3.25
80	-5.00	+3.25

LENS: **Single Vision**
 INDEX: **1.67 Aspheric**
 MATERIAL:
 COLOURS:

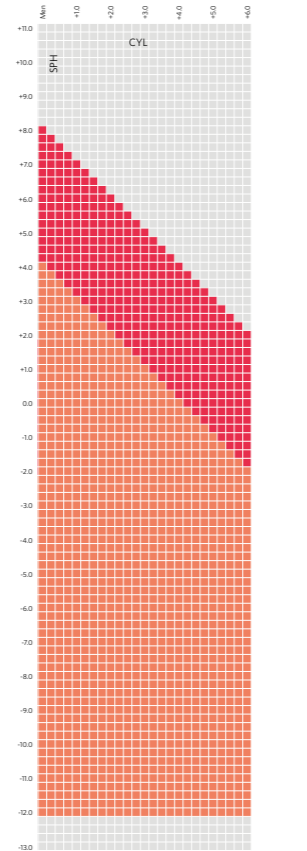

Dia.	Max. minus	Max. plus
50	-10.00	+8.00
55	-10.00	+8.00
60	-10.00	+8.00
65	-10.00	+8.00
70	-12.00	+4.00

LENS: **Single Vision**
 INDEX: **1.67**
 MATERIAL: Transitions®
 COLOURS: Green*/Grey/Brown

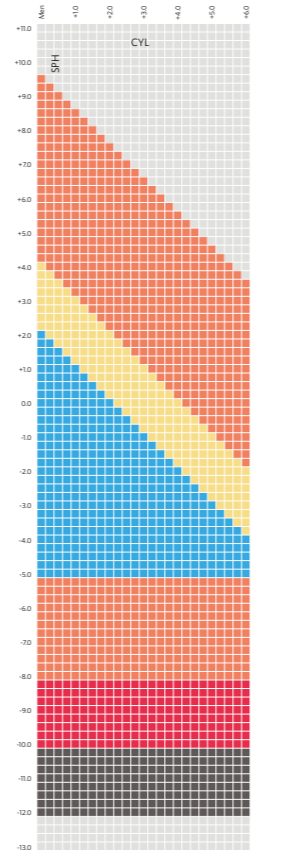

Dia.	Max. minus	Max. plus
50	-12.00	+9.50
55	-12.00	+9.50
60	-12.00	+9.50
65	-10.00	+9.50
70	-8.00	+9.50
75	-5.00	+4.00
80	-5.00	+2.00

LENS: **Single Vision**
 INDEX: **1.74 Aspheric**
 MATERIAL:
 COLOURS:

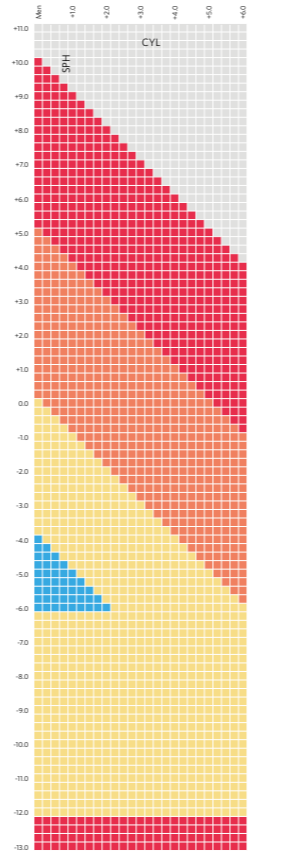

Dia.	Max. minus	Max. plus
50	-18.00	+10.00
55	-18.00	+10.00
60	-18.00	+10.00
65	-18.00	+10.00
70	-12.00	+5.00
75	-12.00	+0.00
80	-6.00	-4.00

FINISHED SINGLE VISION STOCK LENSES

LENS: **Finished Single Vision**
 INDEX: **1.50**
 COATING:
 COLOURS:

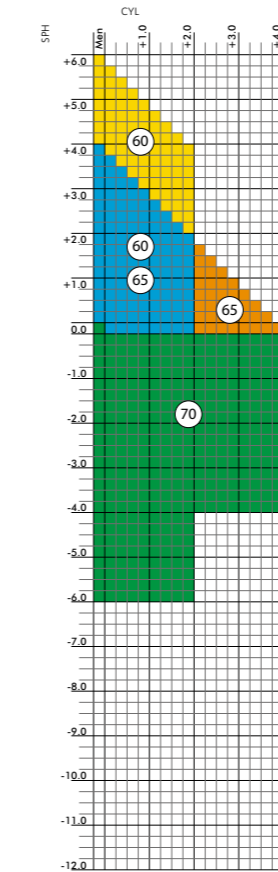

LENS: **Finished Single Vision**
 INDEX: **1.50**
 COATING: KODAK Clean & Clear
 COLOURS:

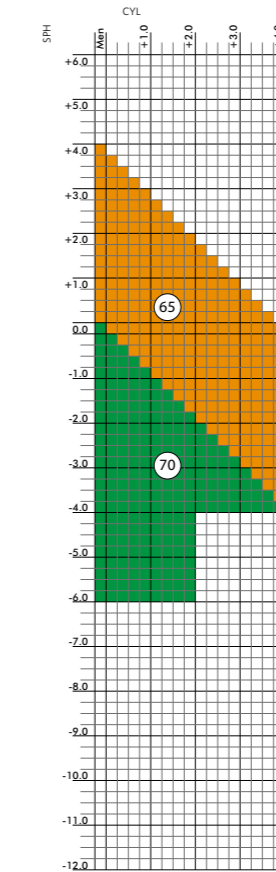

LENS: **Finished Single Vision**
 INDEX: **1.50**
 COATING: KODAK BluProtect
 COLOURS:

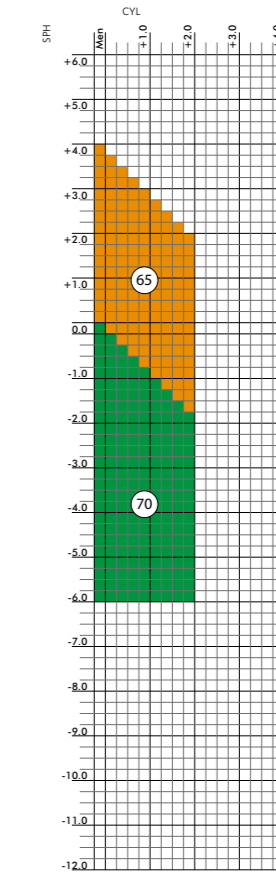

LENS: **Finished Single Vision**
 INDEX: **1.50**
 COATING: KODAK Clear (back surface)
 MATERIAL: Pretinted
 COLOURS: Green*/Grey/Brown

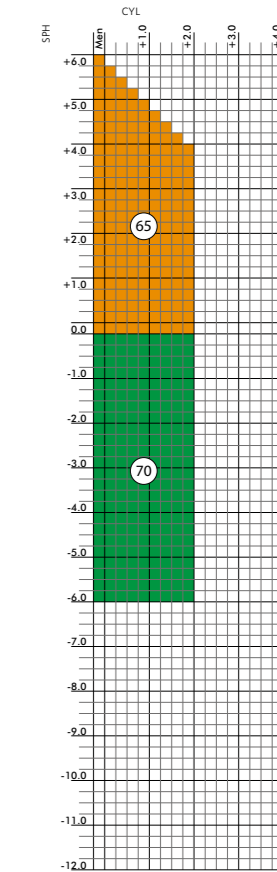

FINISHED SINGLE VISION STOCK LENSES

LENS: **Finished Single Vision**
 INDEX: **1.50**
 MATERIAL: Transitions®
 COATING: HC, KODAK Clear
 COLOURS: Green/Grey/Brown

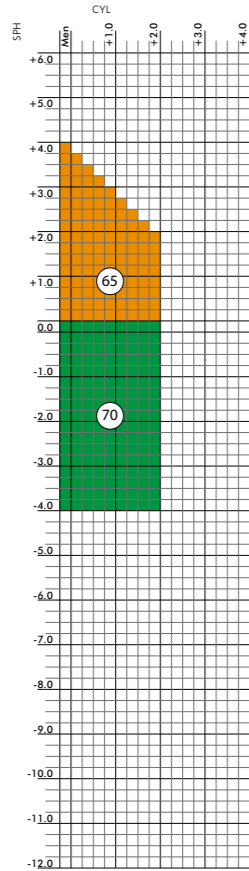

LENS: **Finished Single Vision**
 INDEX: **1.53**
 MATERIAL: Trivex
 COATING: KODAK Clear
 COLOURS:

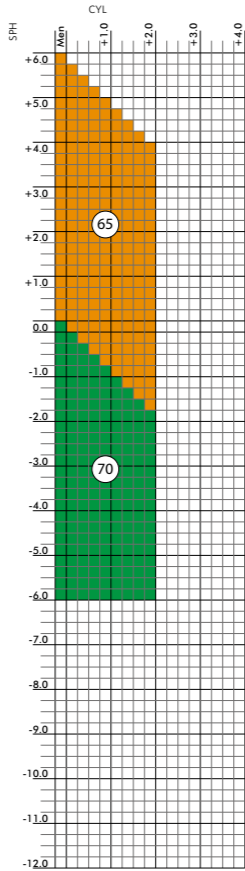

LENS: **Finished Single Vision**
 INDEX: **1.59**
 MATERIAL: Polycarbonate,
 COATING: HC, KODAK Clear
 COLOURS:

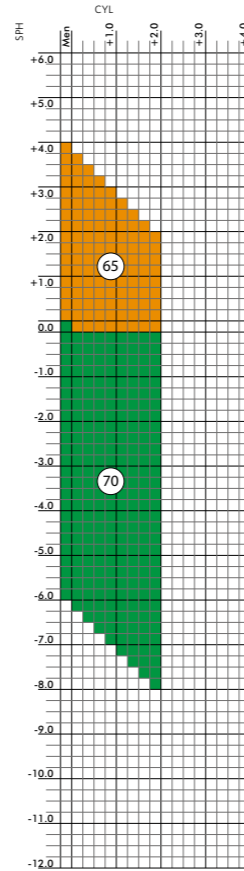

LENS: **Finished Single Vision**
 INDEX: **1.60**
 COATING: KODAK Clear,
 KODAK Clean & Clear
 COLOURS:

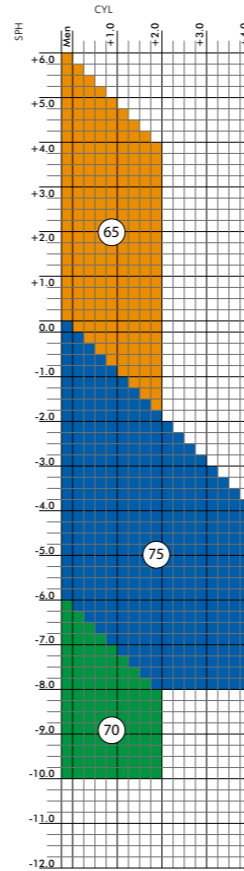

LENS: **Finished Single Vision**
 INDEX: **1.60 Aspheric**
 COATING: KODAK Clear
 COLOURS:

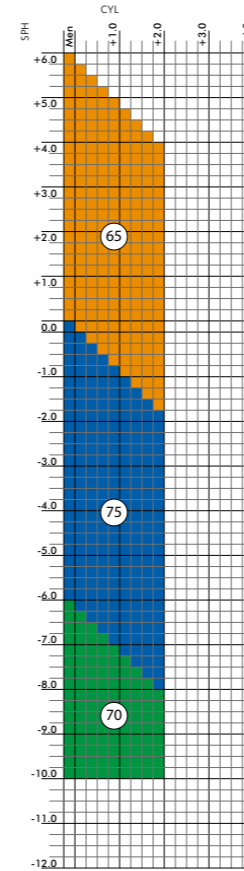

LENS: **Finished Single Vision**
 INDEX: **1.60**
 COATING: KODAK BluProtect
 COLOURS:

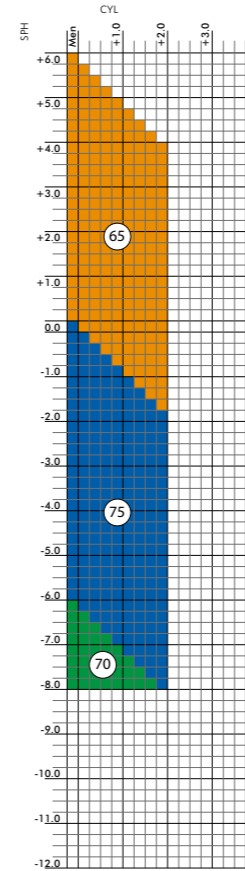

LENS: **Finished Single Vision**
 INDEX: **1.60**
 MATERIAL: Pretinted
 COATING: KODAK Clear
 (back surface)
 COLOURS: Green/Grey/Brown

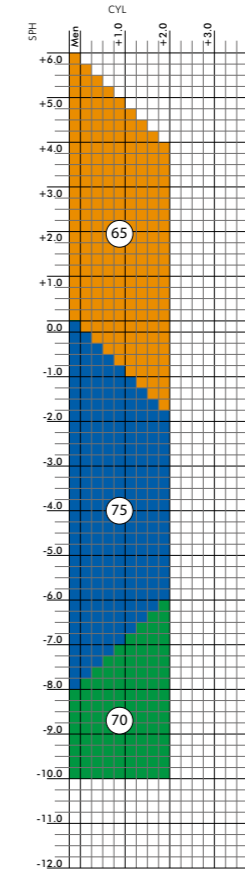

LENS: **Finished Single Vision**
 INDEX: **1.60**
 MATERIAL: Transitions®
 COATING: KODAK Clear
 COLOURS: Green*/Grey/Brown

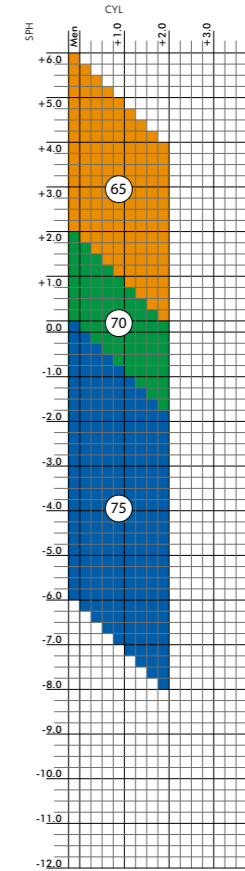

*Max range -6.00 +4.00



FINISHED SINGLE VISION STOCK LENSES

LENS: **Finished Single Vision**
 INDEX: **1.67**
 COATING: KODAK Clear,
 KODAK Clean & Clear
 COLOURS:

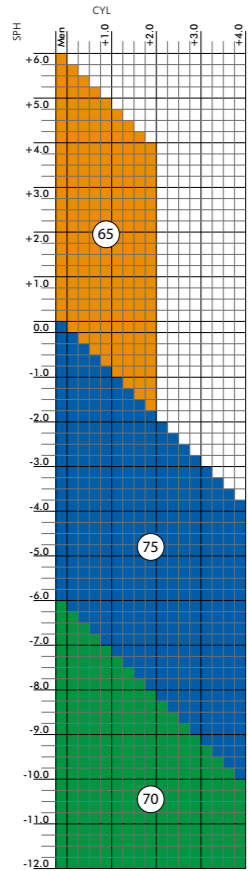

LENS: **Finished Single Vision**
 INDEX: **1.74 Aspheric**
 COATING: KODAK Clear
 COLOURS:

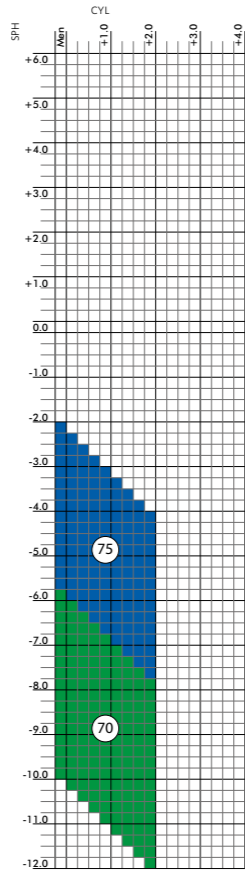

LENS: **Finished Single Vision**
 INDEX: **1.74 Aspheric**
 COATING: KODAK Clean & Clear
 COLOURS:

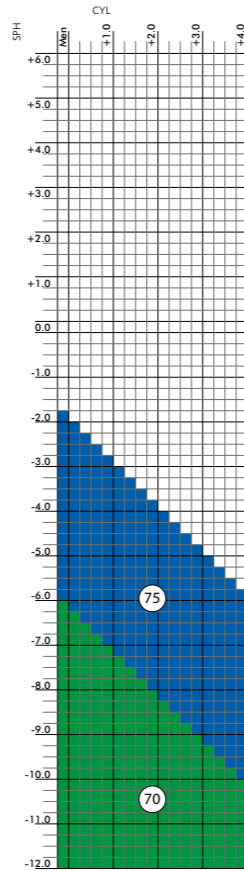



Signet Armorlite Europe

1-7 Apollo, Olympus Park
Quedgeley, Gloucester, GL2 4NF
T: 01452 720 201
F: 01452 720 004
www.saeurope.co.uk

HOW TO ORDER

CALL 01452 887 400

EMAIL orders@kodaklens.co.uk

FAX 01452 720 004

ONLINE www.saeurope.co.uk

OR CONTACT YOUR KODAK LENS REGIONAL MANAGER



The KODAK trademark and trade dress are used under license from KODAK by Signet Armorlite, Inc. ©2016. Transitions and the swirl are registered trademarks of Transitions Optical, Inc., used under license by Transitions Optical Limited. ©2016 Transitions Optical Limited. All trademarks and registered trademarks are property of registered users.

Kodak LENS



SA

Signet Armorlite
Lens Manual

Contents

Introduction	3
Single Vision Lenses	4-5
Digital Progressive Lenses	6-9
Signia™ Range	
Occupational Lens	10-11
SA Xcel	
Traditional Progressive Lenses	12-13
Navigator™ Range	
Bifocal Lenses	14
FT28, FT35, RD24, CT25, CT28	
Sun Lenses	15-18
Tints, Polarised	
Photochromic	19-21
Photoviews	
Lens Finishes	22-24
Signet Anti-Reflection, Ezy Clean	

Range Charts	25
Digital Progressives	26-30
Navigator™	30-31
Navigator™ Short	32
Xcel	33
Traditional Bifocal	34-35
Conventional Single Vision	36
Finished Single Vision	37
Terms and conditions	38-39

Introduction

Our industry leading technologies summarised:

Lens Technology	Feature	Benefit	Signia™	Signia™ Plus	Signia™ Premium
Digital Freeform Lenses	Digital surfacing technology uses over 5,000 reference points to shape the lens geometry	Enhanced prescription accuracy across the lens. Sharper vision with wider field of view.	✓	✓	✓
Variable Decentration	Allows variable placement of the lens design within the blank without the necessity of using a standard optical centre	Thinner lenses with a more balanced edge thickness	✓	✓	✓
Vision First Design™	The lens design incorporates binocular balance providing a balanced visual experience throughout the lens	Less soft focus areas for sharper, more natural vision		✓	

Signet Armorlite Europe supplies laboratories and opticians around the world with high quality lenses, designed and created using the latest lens technology.

Single Vision Lenses

Signet Armorldite Single Vision Lenses are available in a wide range of powers and materials. This gives the patient more options to personalise the lens to their requirements, for example a patient may prefer a thinner lenses which can be achieved through ordering higher index lenses.

Also available in the following:

Transitions®
XTRActive®

PHOTOVIEWS™

POLARISED

Transitions®
Signature™ VII

PRE-TINTED



Digital Progressive Lenses

Signia™

Signia™ is a digital progressive lens that successfully combines a soft design with wide distance, intermediate and reading areas. This design also benefits from having low rates of change in mean power and maintains good dynamic vision throughout.

RANGE AVAILABILITY

	1.50	1.60	1.67
Clear	✓	✓	✓
Photoviews	✓	✓	
Polarised	✓		

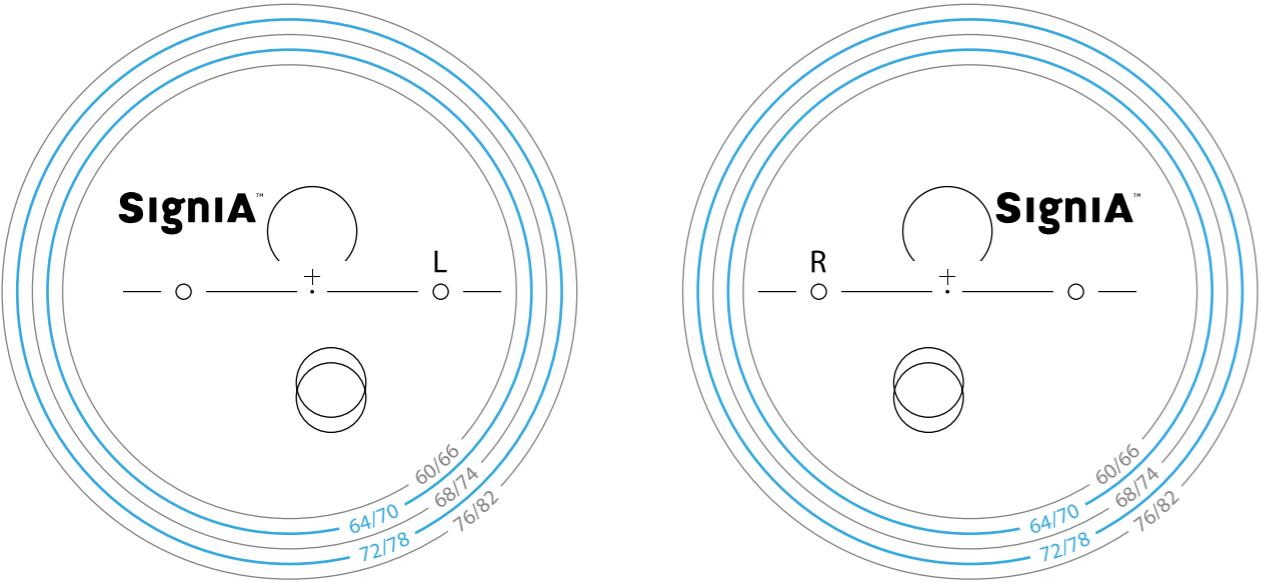

Signia™ Plus

Signia™ Plus is a digital progressive lens that consists of soft, aspheric designs with low levels of distortion taking into consideration the natural viewing position of the eye. The three corridor lengths enable dispensing opticians to increase the patient's frame choice and enhance their viewing comfort.

RANGE AVAILABILITY

	1.50	1.60	1.67
Clear	✓	✓	✓
Photoviews	✓	✓	
Polarised	✓	✓	✓
Transitions®	✓	✓	✓

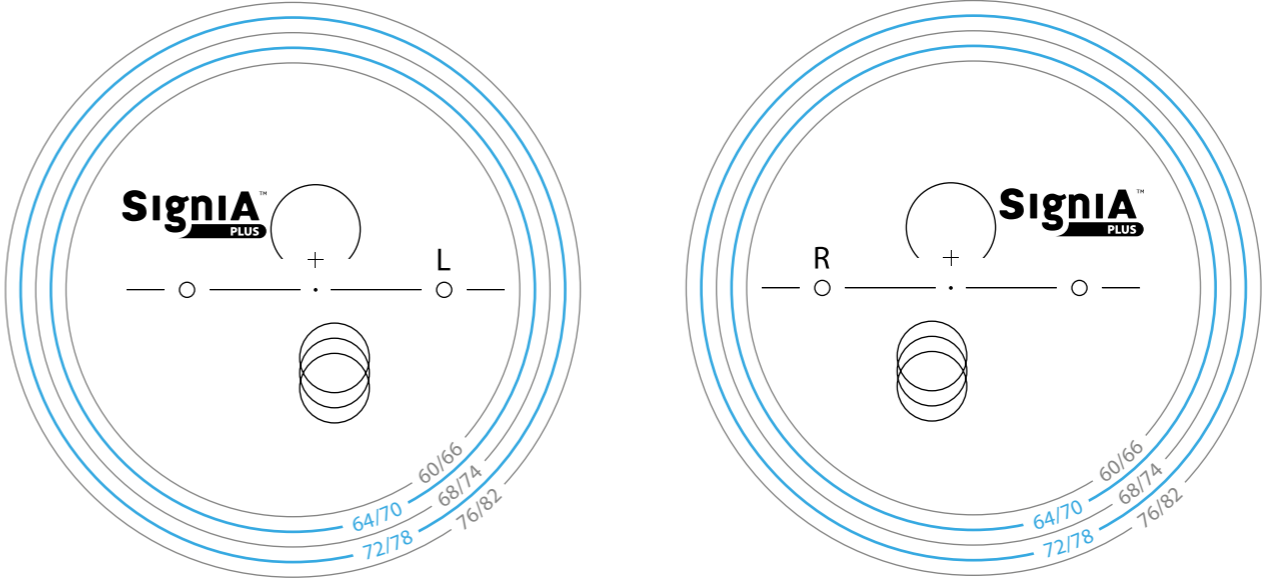

Transitions® Available with Transitions®. See range availability chart for details



Digital Progressive Lenses

Signia™ Premium

Signia™ Premium is a digital progressive lens that has been designed using Vision First Design™ technology. This advanced approach has allowed Signia™ Premium to be designed with a very smooth mean power, minimising “swim” effect and providing exceptional patient comfort and rapid adaptation.

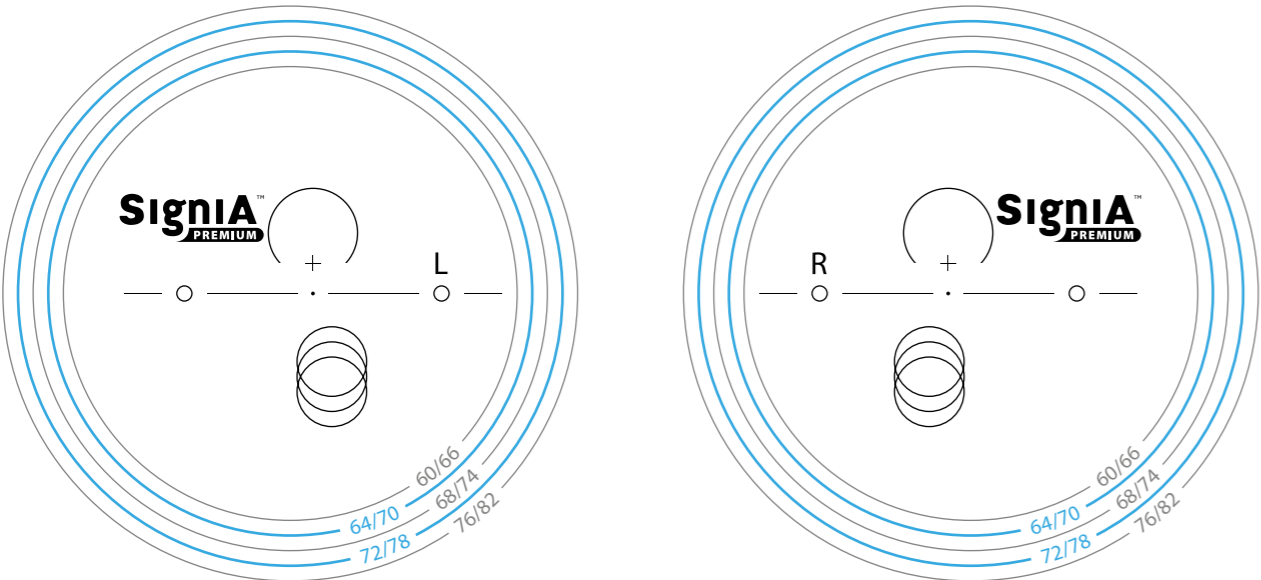

Transitions®

Available with Transitions.
See range availability chart for details

RANGE AVAILABILITY

	1.50	1.53	1.59	1.60	1.67	1.74
Clear	✓			✓	✓	✓
Photoviews	✓			✓		
Polarised	✓			✓	✓	
Transitions®	✓			✓	✓	
Transitions® XTRActive™	✓			✓	✓	
Polycarbonate			✓			
Trivex		✓				
Trivex Transitions®		✓				

SIGNIA™ RANGE BENEFITS

- Width of full power at reading position
- Smoothness of mean power
- Clarity of peripheral vision
- Digitally produced for a wider field of view with better image stability and less distortion

SIGNIA™

Minimum Fitting Height	15mm, 17mm
Corridor Length	14mm, 16mm
Minimum Distance to Top Rim	9mm
Fitting Cross above Prism Reference Point	2mm
Decentred	3mm

SIGNIA™ PLUS AND SIGNIA™ PREMIUM

Minimum Fitting Height	14mm, 16mm, 18mm
Corridor Length	13mm, 15mm, 17mm
Minimum Distance to Top Rim	9mm
Fitting Cross above Prism Reference Point	4mm
Decentred	3mm

Occupational Lens

SA Xcel

SA Xcel lens is an occupational progressive lens designed primarily for use in an office-type environment. This lens provides more comfortable near and intermediate vision with minimal distortion due to a wider reading and intermediate area. This provides patients with a much broader area of clear vision for the visual distances required within a typical office environment. This also limits the head and neck movement required for clear vision. Therefore these lenses can reduce both eye fatigue and improve posture in this environment.

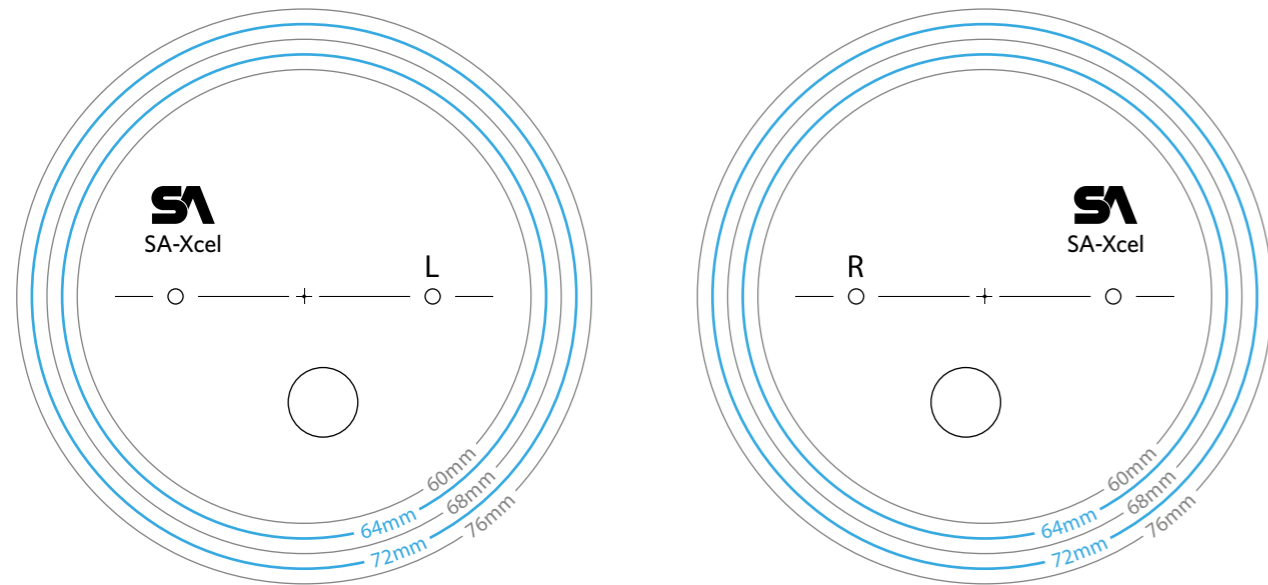

SA XCEL BENEFITS

- Made specifically for desk use, minimising distortion in this environment
- No head movement required for clear vision resulting in better posture
- Reduced eye fatigue

Minimum Fitting Height	15mm
Corridor Length	14mm
Minimum Distance to Top Rim	11mm
Fitting Cross above Prism Reference Point	0mm

Degression powers
0.75, 1.25, 1.75, 2.25

Traditional Progressive Lenses

Navigator™

Navigator™ is a traditional entry level progressive lens. The soft design is a pre-moulded front surface design. This competitively priced lens offers a range of lens materials to choose from, including a high index and photochromic option.

Minimum Fitting Height	20mm
Corridor Length	18mm
Minimum Distance to Top Rim	9mm
Fitting Cross above Prism Reference Point	2mm
Decentred	2.5mm

RANGE AVAILABILITY

	1.50	1.59	1.60
Clear	✓	✓	✓
Photoviews	✓		
Polarised	✓		

Navigator™ Short

Navigator™ Short traditional lens design is based on the original Navigator™. The design allows for a greater range of frames to be fitted with a traditional front surface progressive lens. This excellent soft lens design is available in a number of materials at very competitive prices.

Minimum Fitting Height	15mm
Corridor Length	14mm
Minimum Distance to Top Rim	9mm
Fitting Cross above Prism Reference Point	2mm
Decentred	3mm

NAVIGATOR™ RANGE BENEFITS

- Soft design for easier adaption
- Wide reading area
- Ideal for the budget-conscious patient

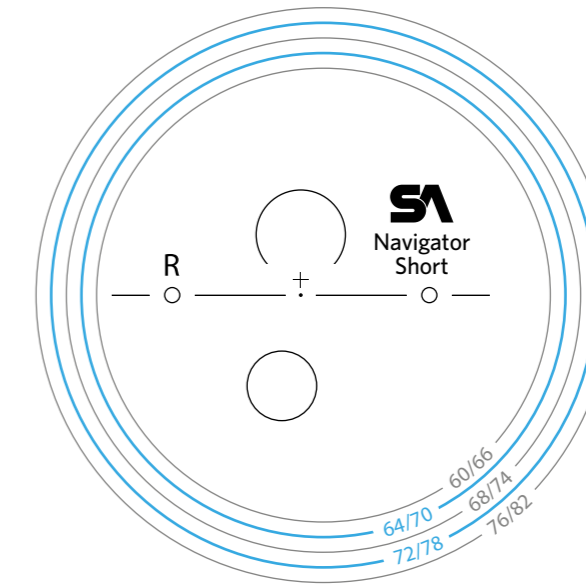
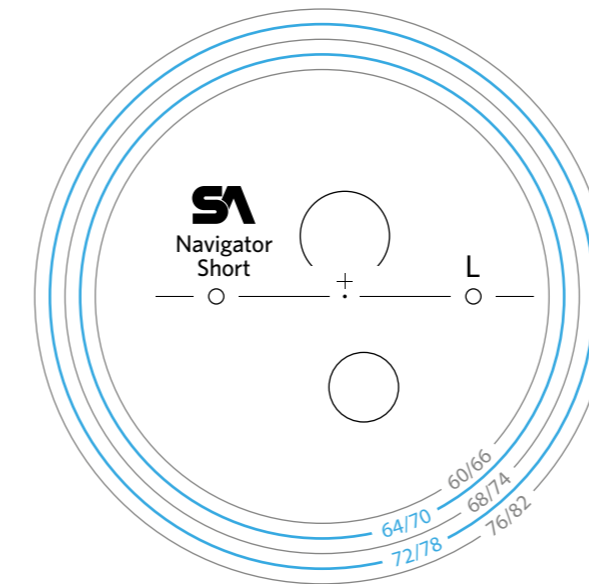
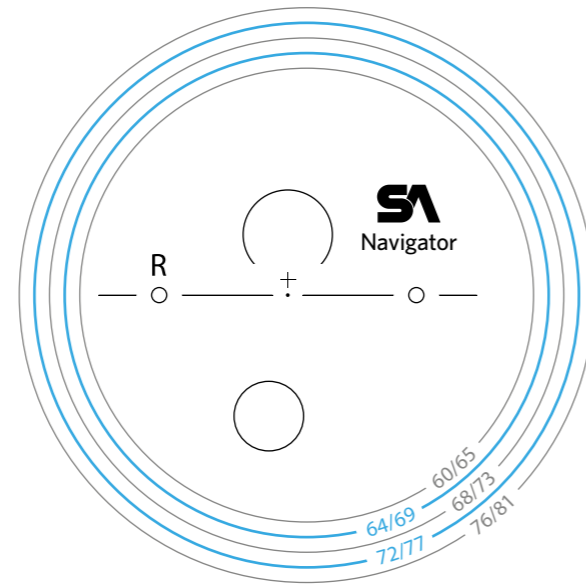
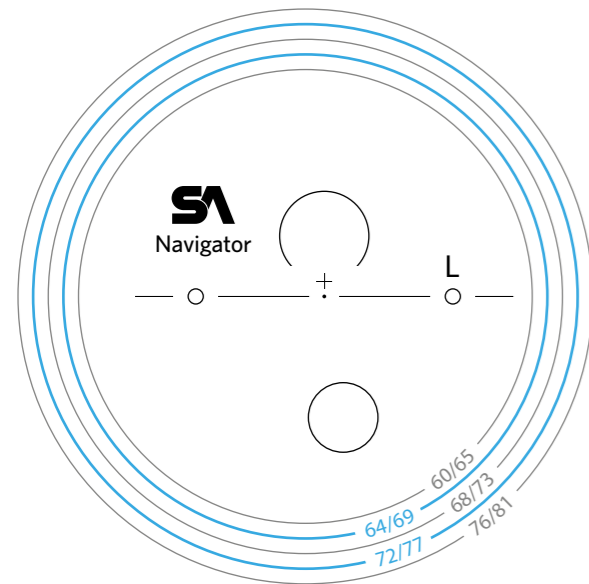

RANGE AVAILABILITY

	1.50	1.60
Clear	✓	
Photoviews	✓	✓

Bifocal Lenses

FT28, FT35, RD24, CT25, CT28

Bifocal lenses allow patients to have two prescriptions in one lens typically for reading in the lower half and distance in the upper half. Unlike progressive lenses these powers are visible within the lens for a more traditional look.

This competitively priced range of bifocals are ideal for NHS patients.

The following SA bifocals are available; FT35 (flat top), FT28 (flat top), RD24 (round) and CT25 (curved top), CT28 (curved top).

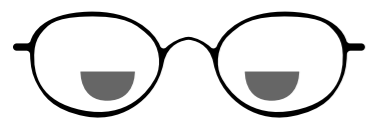

Flat top

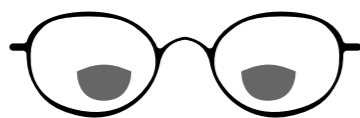

Curved top

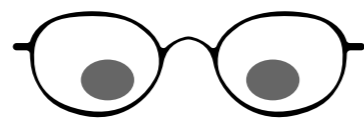

Round



Sun Lenses



Tints

We offer a wide range of coloured tints, from the traditional brown and greys to the more specific colours, such as green or yellow.

A colour tint can enhance the visual performance of spectacles for certain sports or activities. There is no certain rule for which colour tint best suits which sport but a brief guide based on our experience is below.

- Skiing Brown, Red/Orange or Grey
- Golf Green or Grey
- Tennis Green
- Running Green or Grey
- Cycling Yellow

Blueblocker

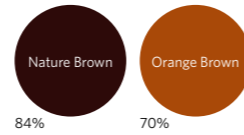
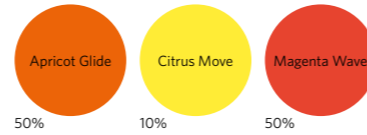

Specialist

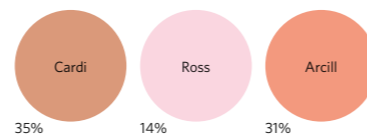
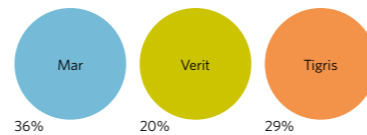
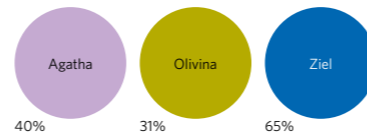

Brown

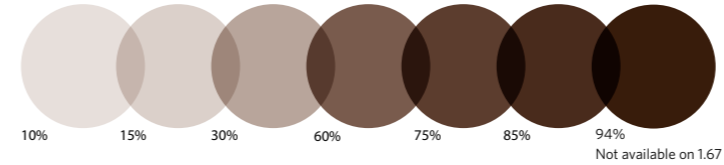

Grey

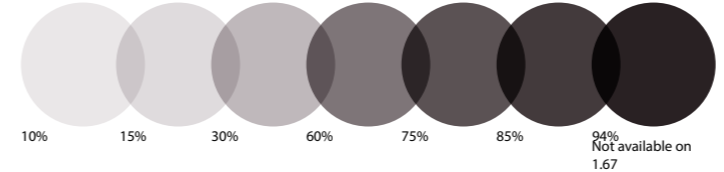

Grey-Green

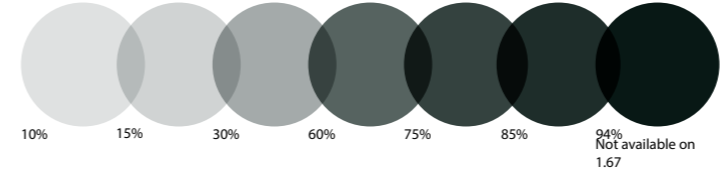

Graphite Green

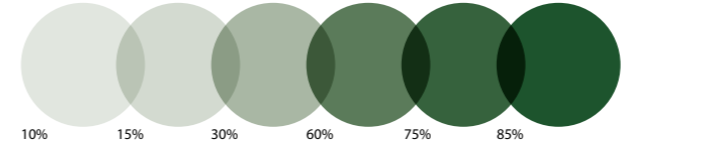

Blue

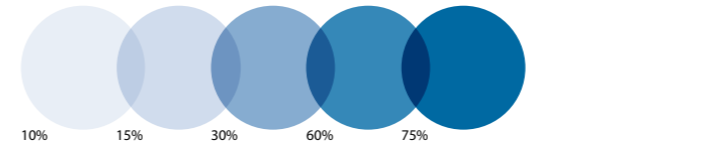

Gradient

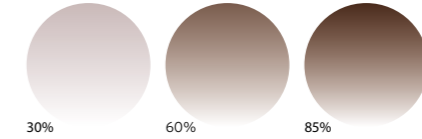

Gradient

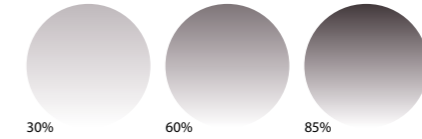

Gradient

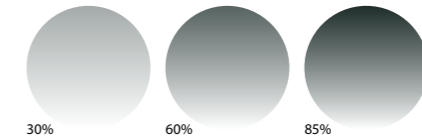

Gradient

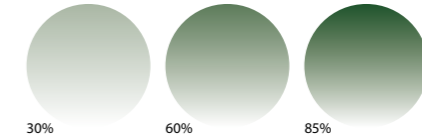

Gradient

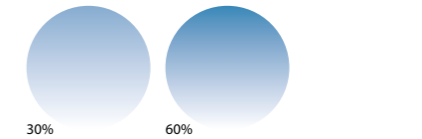

Due to reprographic process, colours shown are for indication only, and may not match exactly. Tints may also be affected by lens prescription, index and coatings.

Polarised

Polarised lenses greatly reduce harsh reflected glare whilst also protecting the patient's eye from harmful 100% of UV rays.

Due to the nature of polarised lenses only vertical light is passed through to the eye completely eliminating glare. Glare is usually reflected off roads, water, snow, glass and metal making these lenses ideal for driving, skiing, fishing, cycling, golf and many more outdoor activities.

WEARER BENEFITS

- Eliminates glare
- Better contrast gives more accurate colour and depth perception
- Protect eyes from UV rays
- Excellent for driving and outdoor sports

RANGE AVAILABILITY

	1.50	1.60	1.67
Navigator™	✓	✓	✓
Signia™	✓	✓	
Signia™ Plus	✓	✓	✓
Signia™ Premium	✓	✓	✓

COLOURS



Grey



Brown

SUITABLE FOR

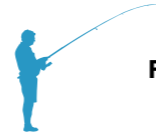

FISHING



GOLF



CYCLING



SKIING



DRIVING

Photochromic Lenses

Photoviews

Photoviews are an effective entry level photochromic lens for comfortable vision in any light conditions whether that's in the office, at home or in the garden.

The lenses provide full UV light protection and feature a fade-back time of 5 minutes. These light reactive photochromic lenses adjust to the lighting conditions to protect the patient's eyes and improve visual comfort throughout the day.

COLOURS



Grey



Brown

RANGE AVAILABILITY

	1.50	1.53	1.59	1.60	1.67	1.74
Stock FSV HC	✓					
Rx Single Vision	✓			✓		
Navigator™	✓					
Navigator™ Short	✓					
Signia™	✓			✓		
Signia™ Plus	✓			✓		
Signia™ Premium	✓			✓		
Bifocals	✓*					

*Available on FT28 only

WEARER BENEFITS

- Full UVA and UVB protection
- Better clarity indoors and outdoors
- Comfortable vision in any light
- Dark tint in bright conditions
- Ideal for everyday wear



Lens Finishes

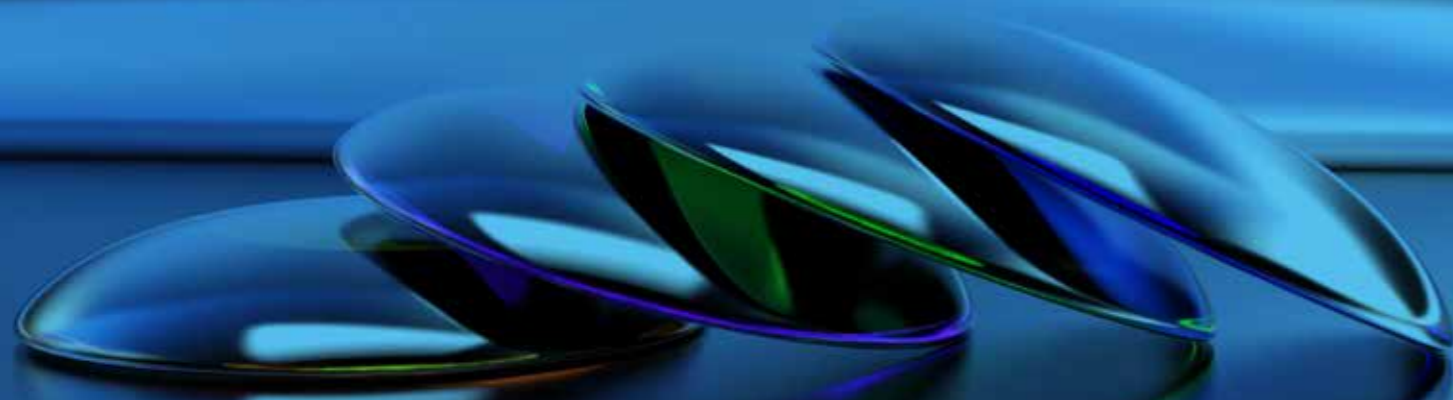

SA Anti-Reflection

SA anti-reflection lens finish efficiently manages how light interacts with the lens. Irritating glare is reduced and reflections on the lenses are eliminated, this improves both the patient's visual experience as well as making their eyes more visible to others which improves the cosmetic appearance of the glasses. The lens finish also increases colour contrast and therefore improves the wearer's visual perception.

WEARER BENEFITS

- Sharper contrast improves visual perception
- Bright irritating glare is reduced
- Improved visual comfort reduces eye strain
- Annoying reflections are eliminated
- Clear lens glasses with reflection free lenses look better

COATING STACK

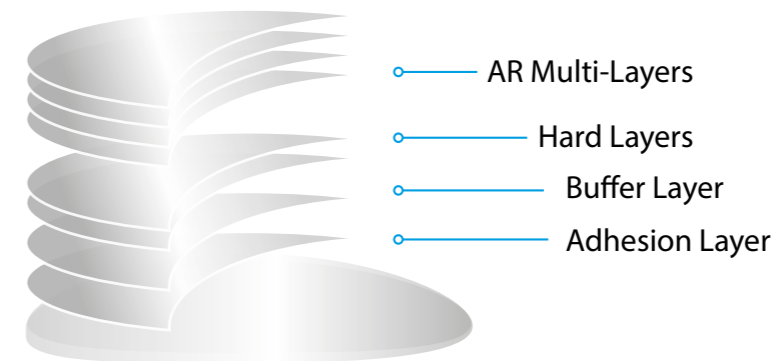

RANGE AVAILABILITY

	1.50	1.53	1.59	1.60	1.67	1.74
Stock FSV HC						
Rx Single Vision	✓			✓		
Navigator™	✓		✓	✓		
Navigator™ Short	✓			✓		
Signia™	✓			✓	✓	
Signia™ Plus	✓			✓	✓	
Signia™ Premium	✓	✓	✓	✓	✓	✓
Bifocals	✓					

Polarised, Transitions and materials may vary - see range pages for more information.

Ezy Clean

Signet Ezy Clean combines the anti-reflective benefits of Signet Anti-Reflection but has also been developed to actively repel dirt, grime and water. This makes the lenses easier to clean than lenses with more traditional anti-reflection coatings which means the wearer benefits from clearer smudge-free vision and less frequent cleaning of the lenses.

RANGE AVAILABILITY

	1.50	1.53	1.59	1.60	1.67	1.74
Stock FSV HC						
Rx Single Vision	✓			✓		
Navigator™	✓		✓	✓		
Navigator™ Short	✓			✓		
Signia™	✓			✓	✓	
Signia™ Plus	✓			✓	✓	
Signia™ Premium	✓	✓	✓	✓	✓	✓
Bifocals	✓					

WEARER BENEFITS

- Lenses stay cleaner for longer
- Sharper contrast improves visual perception
- Bright irritating glare is reduced
- Improved visual comfort reduces eye strain
- Annoying reflections are eliminated
- Clear lens glasses with clean, reflection free lenses look better

COATING STACK

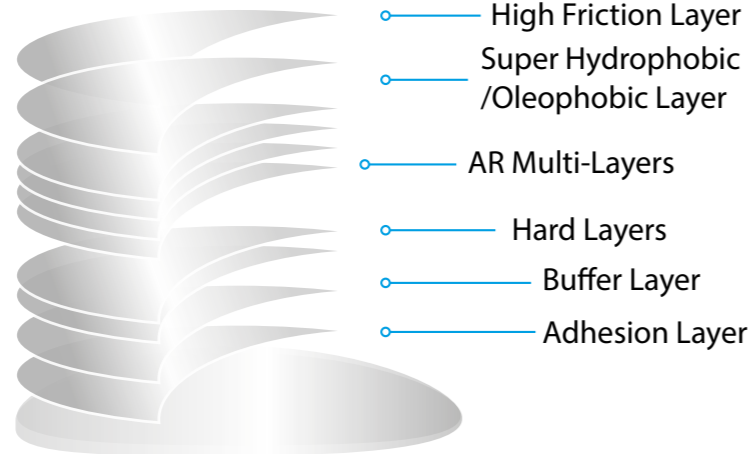

Polarised, Transitions and materials may vary - see range pages for more information.

SA Range Charts

SA DIGITAL PROGRESSIVES

SIGNIA™ PRODUCTS

LENS: **Signia™, Plus & Premium**
 INDEX: **1.50**
 MATERIAL: Clear
 COLOURS:

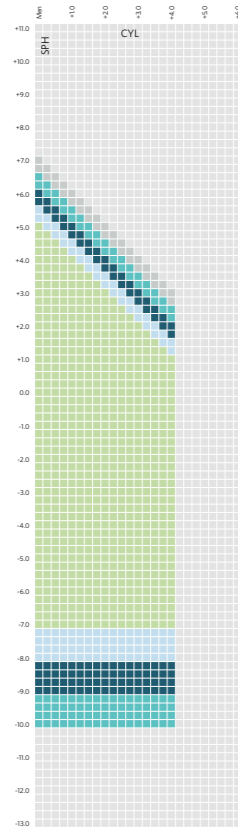

Dia.	Max. Minus	Max. Plus
50/56	-10.00	+8.00
55/61	-10.00	+8.00
60/66	-10.00	+6.50
65/71	-9.00	+6.00
70/76	-8.00	+5.50
75/81	-7.00	+5.00

Add. 0.75 - 3.50

LENS: **Signia™, Plus & Premium**
 INDEX: **1.50**
 MATERIAL: Polarised
 COLOURS: Green/Grey/Brown

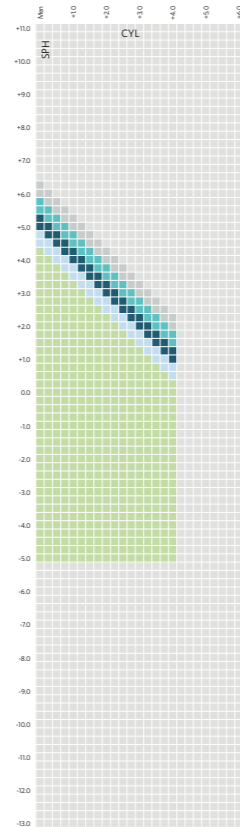

Dia.	Max. Minus	Max. Plus
50/56	-5.00	+6.25
55/61	-5.00	+6.25
60/66	-5.00	+5.75
65/71	-5.00	+5.25
70/76	-5.00	+4.75
75/81	-5.00	+4.25

Add. 0.75 - 3.50

LENS: **Signia™, Plus & Premium**
 INDEX: **1.50**
 MATERIAL: PhotoViews
 COLOURS: Grey/Brown

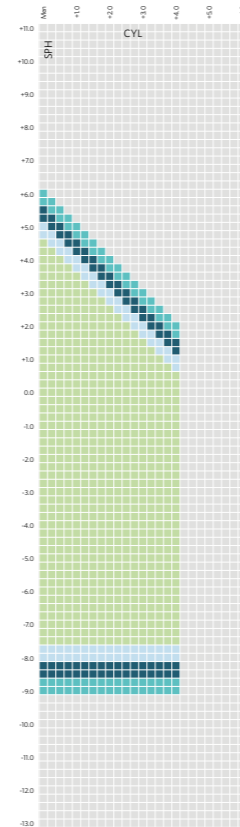

Dia.	Max. Minus	Max. Plus
50/56	-9.00	+6.00
55/61	-9.00	+6.00
60/66	-9.00	+6.00
65/71	-8.50	+5.50
70/76	-8.00	+5.00
75/81	-7.50	+4.50

Add. 0.75 - 3.50

LENS: **Plus and Premium**
 INDEX: **1.50**
 MATERIAL: Transitions®
 COLOURS: Grey/Brown/Green

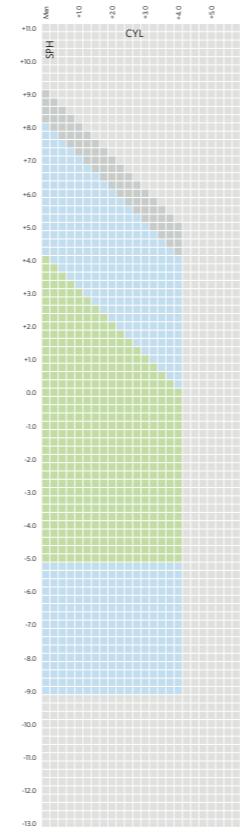

Dia.	Max. Minus	Max. Plus
50/56	-9.00	+9.00
55/61	-9.00	+9.00
60/66	-9.00	+9.00
65/71	-9.00	+9.00
70/76	-5.00	+8.00
75/81	-5.00	+4.25

Add. 0.75 - 3.50

LENS: **Premium**
 INDEX: **1.50**
 MATERIAL: Transitions® XTRActive™
 COLOURS: Green/Grey/Brown

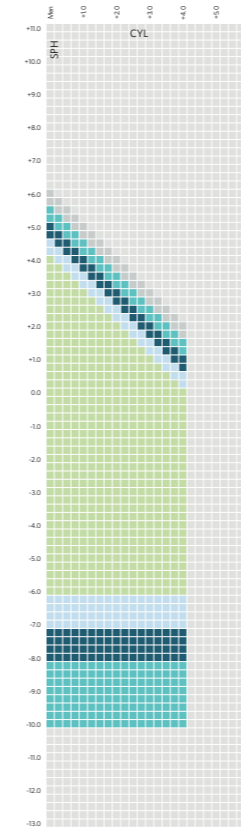

Dia.	Max. Minus	Max. Plus
50/56	-9.00	+6.00
55/61	-9.00	+6.00
60/66	-9.00	+5.50
65/71	-8.00	+5.00
70/76	-7.00	+4.50
75/81	-6.00	+4.00

Add. 0.75 - 3.50

LENS: **Premium**
 INDEX: **1.53**
 MATERIAL: Trivex
 COLOURS:

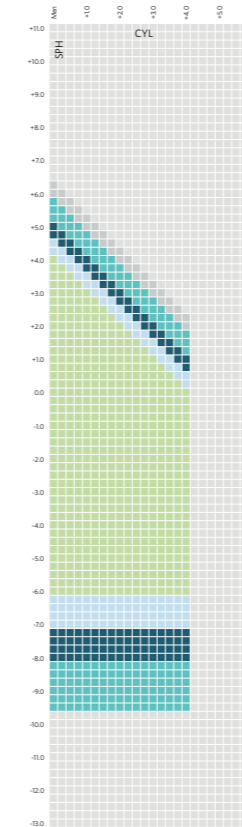

Dia.	Max. Minus	Max. Plus
50/56	-9.50	+6.25
55/61	-9.50	+6.25
60/66	-9.50	+5.75
65/71	-8.00	+5.00
70/76	-7.00	+4.50
75/81	-6.00	+4.00

Add. 0.75 - 3.50

LENS: **Premium**
 INDEX: **1.53**
 MATERIAL: Trivex Transitions®
 COLOURS: Grey/Brown

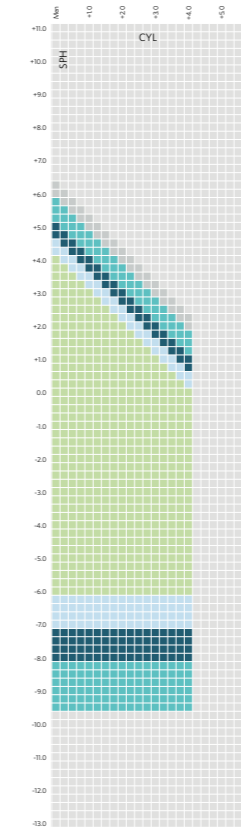

Dia.	Max. Minus	Max. Plus
50/56	-9.50	+6.25
55/61	-9.50	+6.25
60/66	-9.50	+5.75
65/71	-8.00	+5.00
70/76	-7.00	+4.50
75/81	-6.00	+4.00

Add. 0.75 - 3.50

LENS: **Premium**
 INDEX: **1.59**
 MATERIAL: Polycarbonate
 COLOURS:

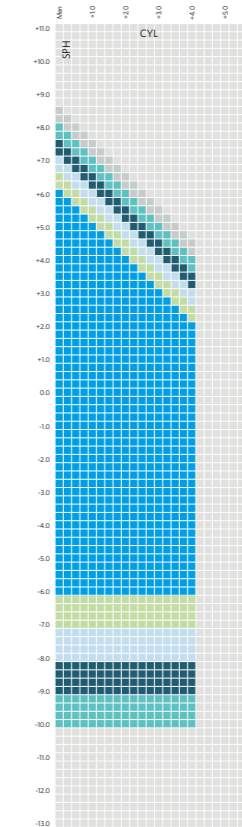

Dia.	Max. Minus	Max. Plus
50/56	-10.00	+8.50
55/61	-10.00	+8.50
60/66	-10.00	+8.00
65/71	-9.00	+7.50
70/76	-8.00	+7.00
75/81	-7.00	+6.50
80/86	-6.00	+6.00

Add. 0.75 - 3.50



SA DIGITAL PROGRESSIVES

SIGNIA™ PRODUCTS

LENS: **Signia™, Plus & Premium**
 INDEX: **1.60**
 MATERIAL: Clear
 COLOURS:

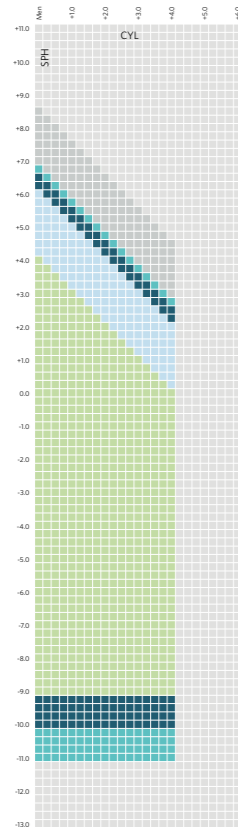

Dia.	Max. Minus	Max. Plus
50/56	-11.00	+8.50
55/61	-11.00	+8.50
60/66	-11.00	+6.75
65/71	-10.00	+6.50
70/76	-9.00	+6.00
75/81	-9.00	+4.00
Add. 0.75 - 3.50		

LENS: **Plus and Premium**
 INDEX: **1.60**
 MATERIAL: Polarised
 COLOURS: Grey/Brown

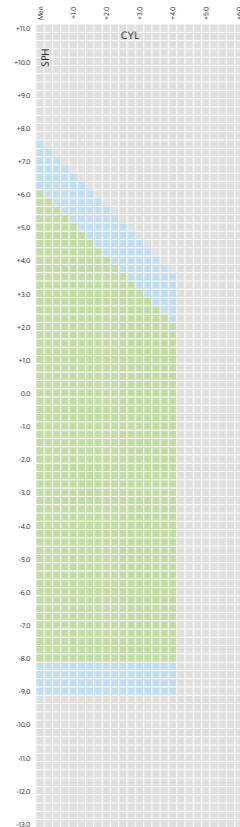

Dia.	Max. Minus	Max. Plus
50/56	-9.00	+7.50
55/61	-9.00	+7.50
60/66	-9.00	+7.50
65/71	-9.00	+7.50
70/76	-9.00	+7.50
75/81	-8.00	+6.00
Add. 0.75 - 3.50		

LENS: **Signia™, Plus & Premium**
 INDEX: **1.60**
 MATERIAL: PhotoViews
 COLOURS: Grey/Brown

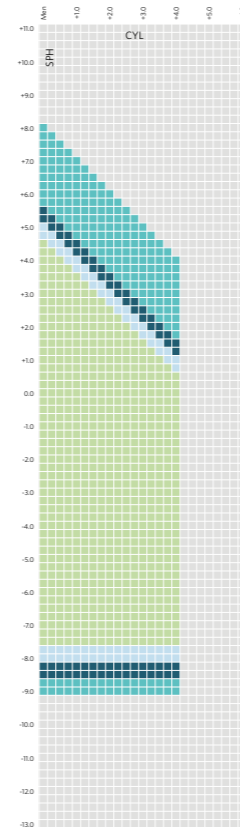

Dia.	Max. Minus	Max. Plus
50/56	-9.00	+8.00
55/61	-9.00	+8.00
60/66	-9.00	+8.00
65/71	-8.50	+5.50
70/76	-8.00	+5.00
75/81	-7.50	+4.50
Add. 0.75 - 3.50		

LENS: **Plus and Premium**
 INDEX: **1.60**
 MATERIAL: Transitions®
 COLOURS: Green/Grey/Brown

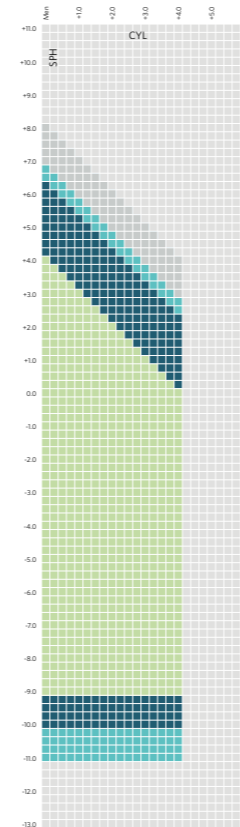

Dia.	Max. Minus	Max. Plus
50/56	-11.00	+8.00
55/61	-11.00	+8.00
60/66	-11.00	+6.75
65/71	-10.00	+6.25
70/76	-9.00	+4.00
75/81	-9.00	+4.00
Add. 0.75 - 3.50		

LENS: **Premium**
 INDEX: **1.60**
 MATERIAL: Transitions® XTRActive™
 COLOURS: Green/Grey/Brown

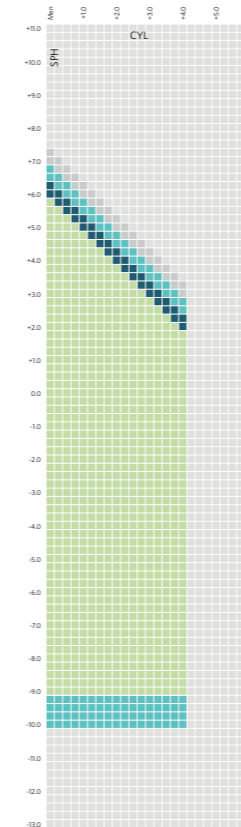

Dia.	Max. Minus	Max. Plus
50/56	-10.00	+7.25
55/61	-10.00	+7.25
60/66	-10.00	+6.75
65/71	-9.00	+6.25
70/76	-9.00	+5.75
75/81	-9.00	5.75
Add. 0.75 - 3.50		

LENS: **Signia™, Plus & Premium**
 INDEX: **1.67**
 MATERIAL: Clear
 COLOURS:

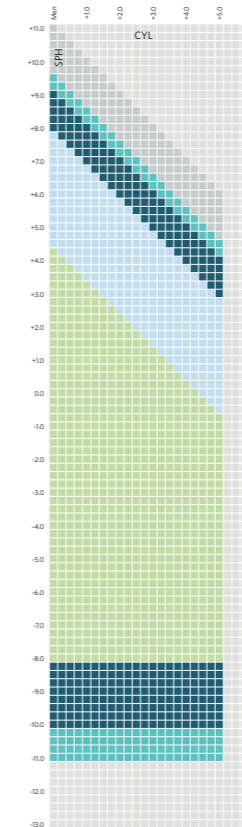

Dia.	Max. Minus	Max. Plus
50/56	-11.00	+11.00
55/61	-11.00	+11.00
60/66	-11.00	+9.50
65/71	-10.00	+9.00
70/76	-8.00	+7.75
75/81	-8.00	+4.25
Add. 0.75 - 3.50		

LENS: **Plus and Premium**
 INDEX: **1.67**
 MATERIAL: Polarised
 COLOURS: Grey/Brown

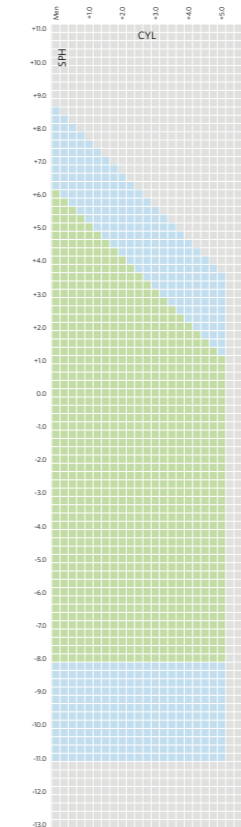

Dia.	Max. Minus	Max. Plus
50/56	-11.00	+8.50
55/61	-11.00	+8.50
60/66	-11.00	+8.50
65/71	-11.00	+8.50
70/76	-11.00	+8.50
75/81	-8.00	+6.00
Add. 0.75 - 3.50		

LENS: **Plus and Premium**
 INDEX: **1.67**
 MATERIAL: Transitions®
 COLOURS: Green/Grey/Brown

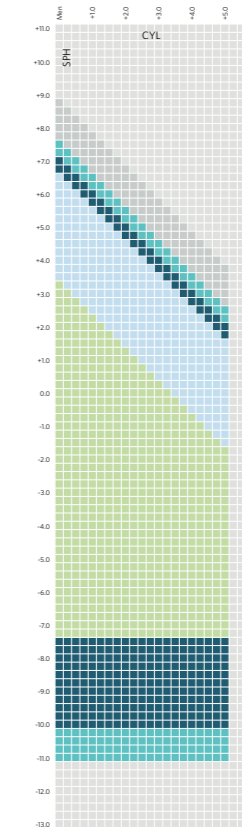

Dia.	Max. Minus	Max. Plus
50/56	-11.00	+8.75
55/61	-11.00	+8.75
60/66	-11.00	+7.50
65/71	-10.00	+7.00
70/76	-7.25	+6.50
75/81	-7.25	+3.25
Add. 0.75 - 3.50		

SA DIGITAL PROGRESSIVES

SIGNIA™ PRODUCTS

LENS: **Premium**
 INDEX: **1.67**
 MATERIAL: Transitions® XTRActive™
 COLOURS: Green/Grey/Brown

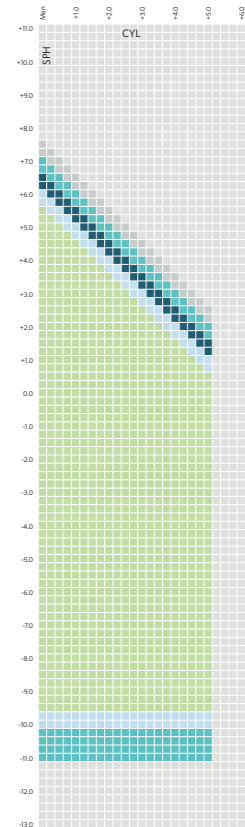

LENS: **Premium**
 INDEX: **1.74**
 MATERIAL: Clear
 COLOURS:

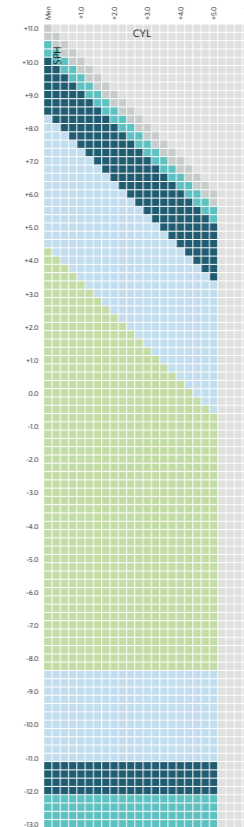

Dia.	Max. Minus	Max. Plus
50/56	-11.00	+7.50
55/61	-11.00	+7.50
60/66	-11.00	+7.00
65/71	-10.00	+6.50
70/76	-10.00	+6.00
75/81	-9.50	+5.50

Add. 0.75 - 3.50

Dia.	Max. Minus	Max. Plus
50/56	-13.00	+11.00
55/61	-13.00	+11.00
60/66	-13.00	+10.50
65/71	-12.00	+10.00
70/76	-11.00	+8.25
75/81	-8.25	+4.25

Add. 0.75 - 3.50

NAVIGATOR™

LENS: **Navigator™**
 INDEX: **1.50**
 MATERIAL: Clear
 COLOURS:

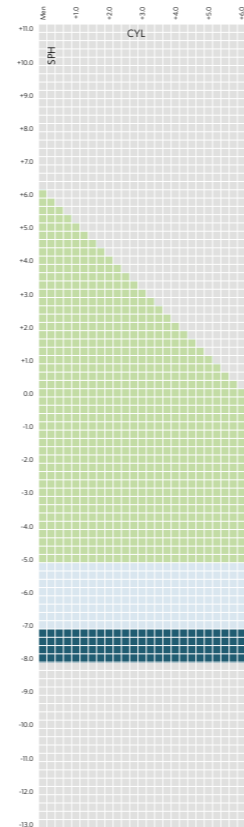

Dia.	Max. Minus	Max. Plus
50/56	-8.00	+6.00
55/61	-8.00	+6.00
60/66	-8.00	+6.00
65/71	-8.00	+6.00
70/76	-7.00	+6.00
75/81	-5.00	+6.00

Add. 0.75 - 3.50

LENS: **Navigator™**
 INDEX: **1.50**
 MATERIAL: Polarised
 COLOURS: Grey/Brown

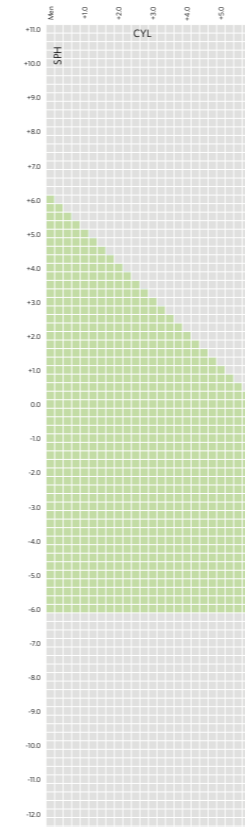

Dia.	Max. Minus	Max. Plus
50/56	-6.00	+6.00
55/61	-6.00	+6.00
60/66	-6.00	+6.00
65/71	-6.00	+6.00
70/76	-6.00	+6.00
75/81	-6.00	+6.00

Add. 1.00 - 3.00

LENS: **Navigator™**
 INDEX: **1.50**
 MATERIAL: PhotoViews
 COLOURS: Grey/Brown

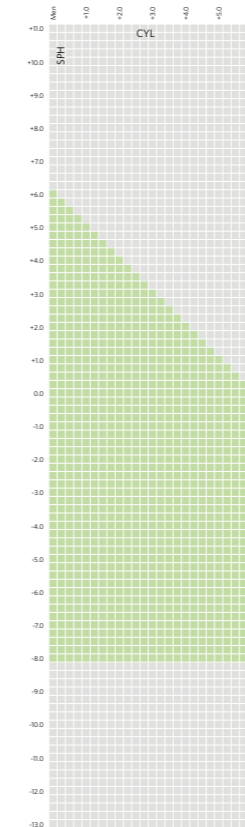

Dia.	Max. Minus	Max. Plus
50/56	-8.00	+6.00
55/61	-8.00	+6.00
60/66	-8.00	+6.00
65/71	-8.00	+6.00
70/76	-8.00	+6.00
75/81	-8.00	+6.00

Add. 1.00 - 3.00

LENS: **Navigator™**
 INDEX: **1.59**
 MATERIAL: Polycarbonate
 COLOURS:

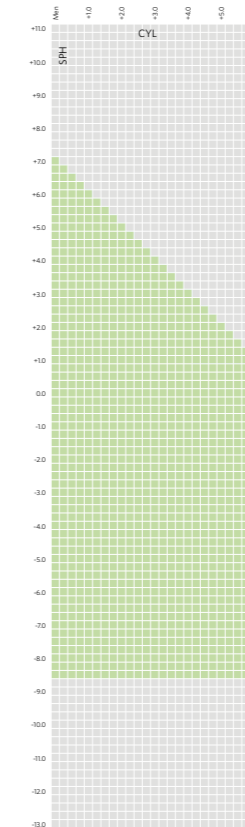

Dia.	Max. Minus	Max. Plus
50/56	-8.50	+7.00
55/61	-8.50	+7.00
60/66	-8.50	+7.00
65/71	-8.50	+7.00
70/76	-8.50	+7.00
75/81	-8.50	+7.00

Add. 1.00 - 3.00

LENS: **Navigator™**
 INDEX: **1.60**
 MATERIAL:
 COLOURS:

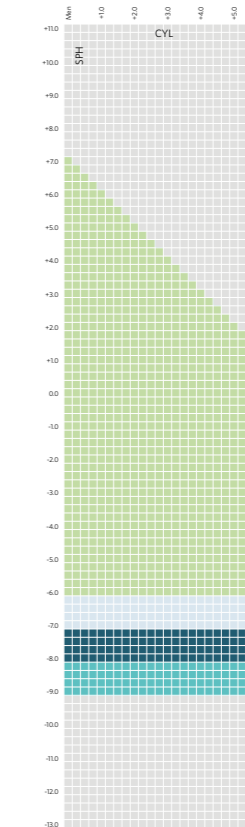

Dia.	Max. Minus	Max. Plus
50/56	-9.00	+7.00
55/61	-9.00	+7.00
60/66	-9.00	+7.00
65/71	-8.00	+7.00
70/76	-7.00	+7.00
75/81	-6.00	+7.00

Add. 1.00 - 3.00

NAVIGATOR™ SHORT

LENS: **Navigator™ Short**
 INDEX: **1.50**
 MATERIAL: Clear
 COLOURS:

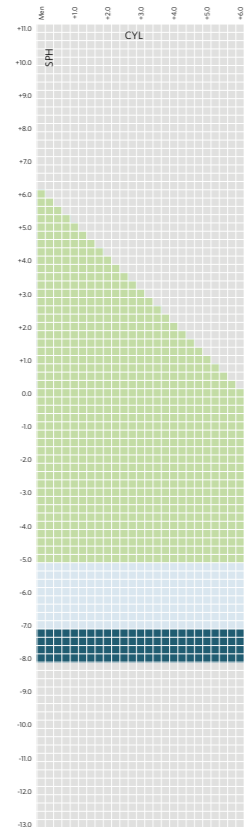

Dia.	Max. Minus	Max. Plus
50/56	-8.00	+6.00
55/61	-8.00	+6.00
60/66	-8.00	+6.00
65/71	-8.00	+6.00
70/76	-7.00	+6.00
75/81	-5.00	+6.00

Add: 1.00 - 3.00

LENS: **Navigator™ Short**
 INDEX: **1.50**
 MATERIAL: PhotoViews
 COLOURS: Grey/Brown

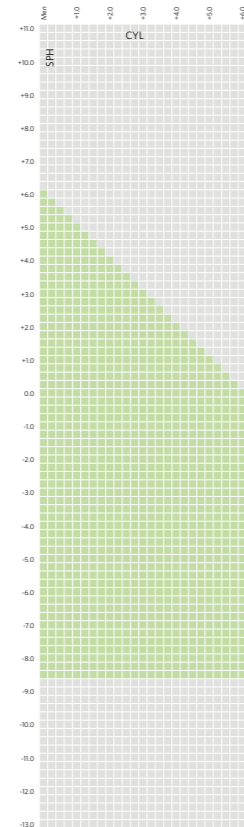

Dia.	Max. Minus	Max. Plus
50/56	-8.50	+6.00
55/61	-8.50	+6.00
60/66	-8.50	+6.00
65/71	-8.50	+6.00
70/76	-8.50	+6.00
75/81	-8.50	+6.00

Add: 1.00 - 3.00

LENS: **Navigator™ Short**
 INDEX: **1.60**
 MATERIAL: Clear
 COLOURS:

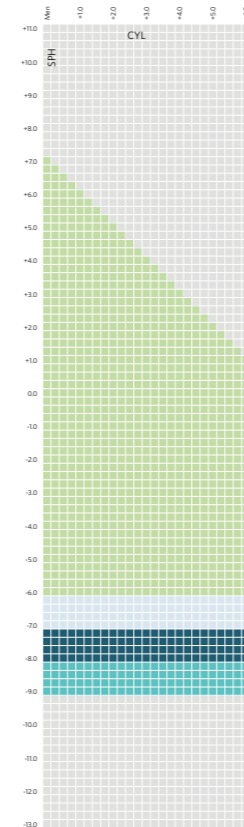

Dia.	Max. Minus	Max. Plus
50/56	-9.00	+7.00
55/61	-9.00	+7.00
60/66	-9.00	+7.00
65/71	-8.00	+7.00
70/76	-7.00	+7.00
75/81	-6.00	+7.00

Add: 1.00 - 3.00

XCEL

LENS: **Xcel**
 INDEX: **1.50**
 MATERIAL: Clear
 COLOURS:

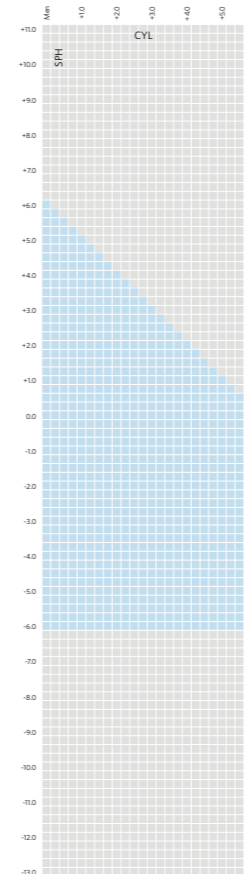

Dia.	Max. Minus	Max. Plus
50/56	-6.00	+6.00
55/61	-6.00	+6.00
60/66	-6.00	+6.00
65/71	-6.00	+6.00
70/76	-6.00	+6.00
75/81	-6.00	+6.00

Degressive add - 0.75, 1.25, 1.75 & 2.25



TRADITIONAL BIFOCALS

LENS: **FT28**
 INDEX: **1.50**
 MATERIAL: Clear
 COLOURS:

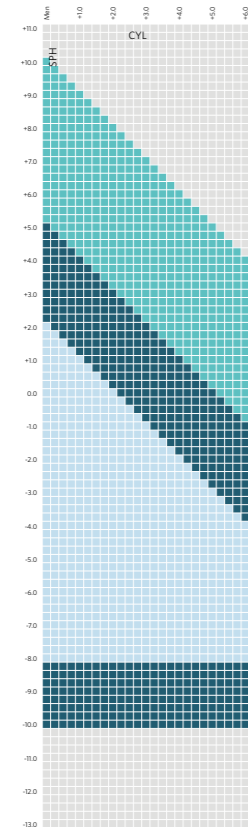

Dia.	Max. Minus	Max. Plus
50/56	-10.00	+10.00
55/61	-10.00	+10.00
60/66	-10.00	+10.00
65/71	-10.00	+5.00
70/76	-8.00	+2.00

Uncoated add: 0.75 to 3.50
 Hardcoated add: 0.75 to 4.00
 - up to 6.00 in 0.50 steps

LENS: **FT28**
 INDEX: **1.50**
 MATERIAL: PhotoViews
 COLOURS: Grey/Brown

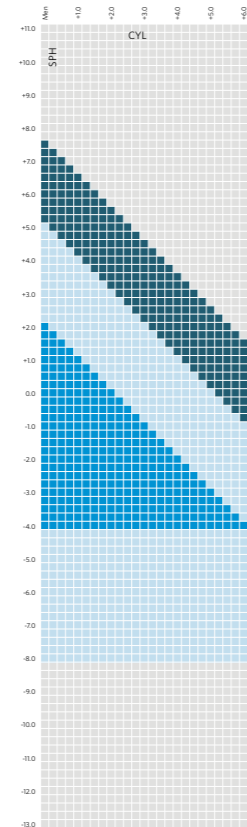

Dia.	Max. Minus	Max. Plus
50	-8.00	+7.50
55	-8.00	+7.50
60	-8.00	+7.50
65	-8.00	+7.50
70	-8.00	+5.00
75	-4.00	+2.00
76	-4.00	+2.00

Add: 1.00 - 3.00

LENS: **CT25/CT28**
 INDEX: **1.50**
 MATERIAL: Clear
 COLOURS:

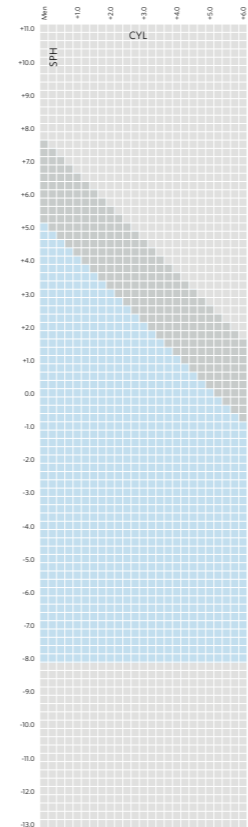

Dia.	Max. Minus	Max. Plus
50/56	-8.00	+7.50
55/61	-8.00	+7.50
60/66	-8.00	+5.00
65/71	-8.00	+5.00
70/76	-8.00	+5.00

Add: 0.75 - 3.50

LENS: **FT35**
 INDEX: **1.50**
 MATERIAL: Clear
 COLOURS:

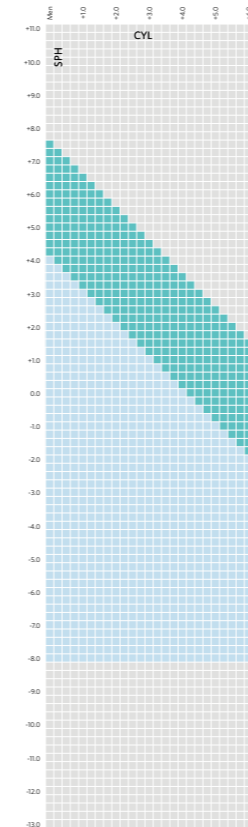

Dia.	Max. Minus	Max. Plus
50/56	-8.00	+7.50
55/61	-8.00	+7.50
60/66	-8.00	+7.50
65/71	-8.00	+4.00
70/76	-8.00	+4.00

Add: 1.00 - 3.00

LENS: **RD24**
 INDEX: **1.50**
 MATERIAL: Clear
 COLOURS:

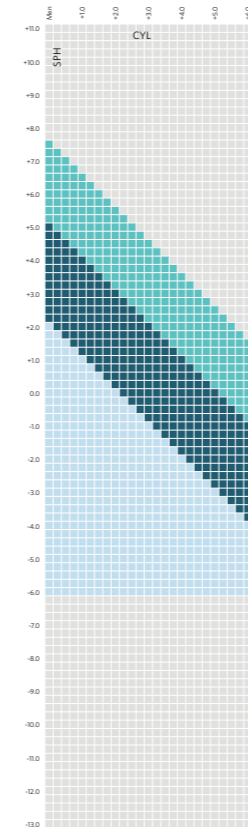

Dia.	Max. Minus	Max. Plus
50	-6.00	+7.50
55	-6.00	+7.50
60	-6.00	+7.50
65	-6.00	+5.00
70	-6.00	+2.00

Add: 1.00 - 3.00



1. Definitions

In these conditions

“**the Company**” means Signet Armorlite Europe Limited
 “**the Customer**” means the individual firm company or other party with whom the Company contracts.

“**Supply**” includes (but is not limited to) any supply under a contract of sale. For the purposes of these conditions a quotation shall include the listing of a product in the Company's current price list as varied by any authorised representative of the Company.

2. General

- Previous dealings between the Company and the Customer shall not vary or replace these terms or be deemed in any circumstances whatsoever so to do.
- No order in pursuance of any quotation or otherwise shall be binding on the Company unless and until such order is accepted by the Company either in writing (which shall include e-mail acknowledgement) or by despatch of the goods ordered. In the case of orders placed through the Company's website, the Customer accepts these conditions by submitting such order. Any contract made between the Company and the Customer (herein called “the Contract”) shall be subject to these conditions and save as aftermentioned no representative or agent of the Company has authority to agree any terms or make any representations inconsistent with them or to enter into any Contract except on the basis of them; any such terms representations or Contract will bind the Company only if in writing and signed by a director.
- Unless otherwise agreed in writing by the company these conditions shall override any terms and conditions stipulated or referred to by the Customer in his order or pre-contract negotiations.
- Any description contained in the Company's catalogues, samples, price lists or other advertising material is intended merely to present a general picture of the Company's products and shall not form a representation or be part of the Contract. All promotional material, price lists, catalogues and other documents prepared by the Company together with the “Presenter” provided for the Customer's use are and will at all times remain the property of the Company and without prejudice to the generality of the foregoing, no drawings or information therein may be copied or reproduced in whole or in part or divulged or transferred to a third party except in the promotion of the Company's products without the Company's written consent.
- In the event that the Company has not given a written acknowledgement of the Customer's order these conditions, provided the Customer shall have had prior notice of them, shall nonetheless apply to the Contract.
- The Company reserves the right to correct any clerical or typographical errors made by its employees at any time. Failure by the Company to enforce any of these conditions shall not be construed as a waiver of any of the Company's rights under the conditions of the Contract.

3. Design and Quality

- The goods supplied under a Contract shall correspond as much as possible with the Company's specification of the goods and shall be of merchantable quality but no warranty is given or shall be implied as to the suitability of the goods for any specific purpose.
- The Company reserves the right to make variations in the design and technical specification of the goods without imposing any obligation upon itself to incorporate such changes with products previously supplied.
- The Company does not nor will it assert or warrant the validity of any letters patent registered design or trade mark applying or applied to any goods supplied by the Company to the Customer under a Contract or that any dealing with any such goods is not or will not be an infringement of any patent design or trade mark rights of third parties.
- All goods will be made within reasonable manufacturing limits

of dimensions. If special accuracy is required the Customer must state specifically in writing the maximum and minimum limits. The Company accepts no responsibility for the accuracy of information or drawings supplied by the Company.

4. Prices

- Subject to any agreement to the contrary the Company's quotations are provisional and may be altered to take account of any changes taking place between the date of quotation and the Company's acceptance of the Customer's order in the price of the products to be supplied and other costs of sale (including any such increase arising from adverse movements in the rate of exchange between the £STG and the currency in which the supply to the Company by the relevant supplier is designated) or in the Customer's instructions or in the event that the Customer orders part only of the quantity referred to in any quotation.
- The Company shall be entitled to increase its prices at any time to take account of any increase in the cost to the Company of purchasing any goods or materials (including any such increase arising from adverse movements in the rate of exchange between the £STG and the currency in which the supply to the Company by the relevant supplier is designated)/(including any such increase arising from any error or inadequacy in any instructions provided by the Customer) and such increased prices ruling at the date of despatch by the Company shall be substituted for the previous Contract price. All prices quoted are exclusive of VAT and the Customer shall pay any and all taxes duties and other government charges payable in respect of the goods.

5. Delivery

- Unless otherwise agreed in writing by the Company the Company agrees to deliver goods to the Customer which shall forthwith give to the Company all necessary instructions to enable such delivery to take place; the Company shall add to the Contract price of the goods a reasonable charge for packaging and delivery and off-loading shall be at the Customer's risk and expense.
- Subject to any agreement in writing by the Company, the risk in goods which the Company agrees to supply within the United Kingdom shall pass to the Customer on delivery or the date (if earlier) on which, the goods being ready for delivery, delivery is postponed at the Customer's request.
- Subject to any agreement in writing by the Company, the risk in goods which the Company agrees to supply outside the United Kingdom shall pass to the Customer in accordance with F.O.B. English Port as defined in Incoterms 1990.
- Should the Customer be unable to accept delivery of the goods at the time when the goods are available for delivery the Company may at its absolute discretion store the goods until actual delivery and the Customer shall be liable to the Company for the reasonable costs of storage handling and carriage. This provision shall be without prejudice to the Customer's liability in damages for failure to take delivery on the contractual date.
- The Company shall not be liable for any loss of or damage sustained by any goods left with the Company howsoever caused and whether or not attributable to negligence on the part of the Company or negligence or willful default on the part of any servant or agent of the Company.
- No claim for damage in transit shortage of delivery or loss of goods will be entertained by the Company unless (1) the Customer shall give to the Company written notice of such damage, shortage or loss either within such time as will enable the Company to comply with the carrier's conditions of carriage or three days, whichever is the shorter, and (2) where the goods have not been checked on acceptance from the carrier, the delivery book of the carrier has been signed “not examined”.
- Should the Company be delayed in or prevented from making delivery of the goods due to war, governmental or parliamentary restrictions, strike, lock-outs, fire, floods, explosions, labour disturbances, trade disputes, damage to or destruction of the goods, breakdown of machinery, shortages of labour or of raw materials or Act of God or due to any other cause whatsoever beyond the

reasonable control of the Company, the Company shall be at liberty to cancel or suspend the order placed by the Customer without incurring any liability for any loss or damage arising there-from.

- While the Company will endeavour to deliver the goods by any date or within any period agreed upon, such dates and periods are estimates only given in good faith and the Company will not be liable for any failure to deliver by such date or within such period. Moreover, the Company shall be entitled to defer delivery until any monies due from the Customer have been received.
- The Company may deliver the goods in instalments unless otherwise agreed. When delivery by instalments is specified each delivery shall for the purpose of this sub-clause only be deemed to constitute a separate contract and the failure of any one or more deliveries shall not be deemed to be a repudiation of the Contract.
- Save as provided by paragraph 7 hereof the Customer shall not be entitled to return goods or refuse to accept delivery without the Company's prior written consent.

6. Payment Terms

- For the purpose of this paragraph the goods shall mean the whole or any instalment of the goods which the Company has agreed to supply and the relevant date shall be the date on which
 - the Company despatches the goods or
 - the Customer defaults in its obligations under sub-paragraph (b) hereof whichever shall first occur.
- Unless otherwise specified in writing by the Company payment shall be made by the Customer net cash not later than 25 days from the statement date. Time for payment shall be of the essence of the contract. Without prejudice to any other rights of the Company interest will be payable on all overdue accounts at 2% per month and the Company shall be entitled to recover all other costs or expenses incurred and for the purpose of paragraphs 7 and 9 hereof the full purchase price of the goods shall include delivery and packaging charges together with any interest payable and costs hereunder. In the case where overdue balances occur we will add collection costs. The Customer shall not be entitled to withhold or set off payment of any amount payable to the Company under this or any other Contract by reason of any dispute which it may have with the Company.
- Without prejudice to any other terms herein if payments to the Company on any account are delayed beyond the due date for payment or if the Customer shall enter into any composition or any arrangement with his creditors or if the Customer being a corporation shall have an administrative receiver or administrator appointed or shall pass a resolution for winding-up or a Court shall make an order to that effect or if there shall be breach of any of the terms and conditions hereof the Company shall be entitled to withdraw credit facilities from the Customer.

7. Cancellation

- If the Customer shall fail to make any payment when it becomes due or shall enter into any composition or any arrangement with his creditors or if being a corporation shall enter into a corporate voluntary arrangement or have an administrative receiver or administrator appointed or shall pass a resolution for winding up or a Court shall make an order to that effect or if there shall be any breach by the Customer of any of the terms and conditions hereof the Company may defer or cancel any further deliveries and treat the Contract of which these conditions form part as determine but without prejudice to its rights to the full purchase price for goods delivered and damages for any loss suffered in consequence of such determination.
- Cancellation by the Customer will only be accepted at the discretion of the Company and in any case on condition that any costs or expenses incurred by the Company up to the date of cancellation and all loss or damage resulting to the Company by reason of such cancellation will be paid by the Customer to the Company forthwith. Acceptance of such cancellation will only be binding on the Company if in writing.

8. Warranty

- Save as otherwise provided in these conditions and with the exception of goods supplied with specific warranty the Company's liability in respect of any defect in or failure of goods supplied is limited to replacing or repairing or paying for the repair or replacement of goods which within a reasonable period after delivery to the Customer are proved to be defective by reason of faulty or incorrect workmanship or materials PROVIDED that the Company's liability (if any) in respect of any direct loss or damage sustained by the Customer as a result of such defect shall not exceed the price of the goods. Conditions precedent to the Company's liability (if any) hereunder shall be that
 - the goods shall have been subject to reasonable and proper use by the user thereof whether or not the Customer shall be able to control such use;
 - the Customer shall have given to the Company reasonable notice of the defect as soon as reasonably practicable;
 - as soon as reasonably practicable the Customer shall have either returned the goods to the Company or provided authority for the Company's servants or agents to inspect them, as the Company may request. The Company shall have no other or further liability in respect of any direct or consequential loss or damage sustained by the Customer arising from or in connection with any such defect.
- All goods sold by the Company are supplied with terms implied by Section 12 of the Sale of Goods Act 1979 and where the Customer is not dealing or holding himself out as dealing in the course of a business sections 13, 14 and 15 thereof. Subject to the Company providing a warranty in the Terms of that provided by the manufacturer and whether or not the Contract is a contract of sale, all other conditions, warranties and other terms express or implied, statutory or otherwise, are expressly excluded, save insofar as contained herein or as otherwise expressly agreed by the Company in writing PROVIDED that if and insofar as any legislation or any order made thereunder shall make or have made it unlawful to exclude or purport to exclude from the Contract any term or shall have made unenforceable any attempt to exclude any such term, the foregoing provisions of this paragraph will not apply to any such term.
- Save as hereinbefore provided and subject to the provision of Section 2(l) of Unfair Contract Terms Act 1977 the Company shall not be liable to the Customer for any damage or for any direct or consequential loss incurred by the Customer in consequence of any negligence on the part of its servants or agents in or in connection with the supply of any goods.

9. Title

- The following provisions shall apply to all Contracts. No failure by the Company to endorse strict compliance by the Customer with such provisions shall constitute a waiver thereof and no termination of the Contract shall prejudice limit or extinguish the Company's rights under this paragraph. Payment shall mean payment in cash such that the Company's acceptance of a cheque shall constitute conditional payment only until such cheque has been cleared and cash received.
 - Upon delivery of the goods the Customer shall hold the goods solely as bailee for the Company and the goods shall remain the property of the Company until such time as the Customer shall have paid to the Company the full purchase price of all goods supplied under the Contract or any other contract. Until such time the Company shall be entitled to recover the goods or any part thereof and for the purpose of exercising such rights the Company, its employees and agents with appropriate transport may enter upon the Customer's premises and any other location where the goods are situated.
 - Before payment in full is made the Customer shall have power to resell the goods as principal towards the sub-customer, but as agent and fiduciary between the Customer and the Company, the proceeds of sale thereby arising belonging accordingly to the Company.
 - The Customer shall maintain all appropriate insurance in respect of the goods from the date or dates on which the risk therein passes to it. In the event of any loss or damage occurring while the goods remain the property of the Company the Customer shall immediately on receipt of the insurance monies, remit to the Company the full purchase price of the goods lost or damaged less any part thereof which has already been paid and until such amount has been so remitted shall hold such amount as trustee and agent for the Company.
 - The licence granted under sub-paragraph (ii) above shall be terminable forthwith at any time upon notice by the Company to the Customer and in any event shall terminate automatically upon the happening of any of the following:-
 - if payments to the Company on any account are delayed beyond the due date for payment;

- if any cheque promissory note bill of exchange or any other negotiable instrument tendered by the Customer shall be dishonoured on first presentation; or
- if the Customer shall enter into any composition or any arrangement with his creditors or if the Customer being a corporation shall have an administrative receiver or administrator appointed or shall pass a resolution for winding-up or a Court shall make an order to that effect or if there shall be breach of any of the terms and conditions hereof.

10. Lien

The Company shall have a general lien over all goods and property of the Customer (whether worked on or not) in the possession of the Company for all unpaid debts due from the Customer and the Company reserves the right upon the expiration of fourteen days notice to dispose of such goods or property and to apply the proceeds of sale (net of costs of sale) towards the payment of such debts.

11. Exports

- In respect of sales of goods outside the United Kingdom (“Export Sales”) the provisions of these conditions shall apply unless inconsistent with the terms of this clause.
- Unless otherwise specifically agreed between the Company and the Customer all Export Sales shall be made:-
 - In the case of existing customers, C.I.F. to the Customers premises and the Company's prices shall be increased to cover the Company's costs in making such deliveries and
 - In the case of new customers, F.O.B. UK Port of Loading.
- Unless otherwise agreed in writing, payment for Export Sales shall be by Confirmed Irrevocable Letter of Credit (“CILC”) issued by a United Kingdom Bank. Such CILC shall allow for transshipment, partial shipment and shall be transferable by the Company.
- The Customer warrants that if an import licence or permit is required for the importation of the goods into the country of destination then such import licence or permit has been obtained or will be obtained prior to shipment.

12. Data Protection Act 1998

- The Customer consents under the Data Protection Act 1998 to the processing of its personal data for the purpose of the Company's business and associated activities, and the passing of this data to credit reference agencies, banks, credit insurers and other responsible organisations.

13. Jurisdiction

- The proper law of all Contracts with the Company shall be English Law which shall govern in all respects the construction and effect of such Contracts and of these conditions. The Customer agrees that in the event of any dispute arising out of the Contract or the performance thereof it will submit to the exclusive jurisdiction of the English Courts.
- These conditions shall not affect the statutory rights of a consumer and nothing in these conditions shall exclude or restrict any liability that the Company may have by virtue of the Consumer Protection Act 1987.

Terms of Acceptance

In placing an order with this company the customer confirms he has verified the mutual compatibility of customer supplied medical device(s) in accordance with the manufacturer's instructions.

Cancellation or Alteration

The customer will be charged for all work carried out up to the time the order is cancelled or altered.

Queries

Any job returned for query must be accompanied by the original order.

Prices

All prices are pounds sterling and per single lens, unless stated otherwise, and are subject to P&P and VAT. All orders are accepted subject to prices ruling at the date of despatch. Where the use of stock lenses will not produce a satisfactory job due to the frame shape, design and/or lens prescription, surfaced lenses will be supplied at the appropriate additional charge. Lens products not shown are charged at nett plus VAT.

Ordering

To assist processing, customers are recommended to use our order forms available on request.

Unless RX orders specify to the contrary, we will ensure correct horizontal centration by supplying large lenses and/or prisms where necessary. In cases where nearest centration is acceptable, this must be stated clearly on the order, along with the blank size to be used.

Orders for half pairs should be sent with the other lens, so that its form can be matched. Orders for half pairs to be prepared must state form required, including height of optical centre above segment on bifocals.

Balance Lenses

When providing requests for balanced lenses, our policy is to:

- Match lens type
- Surface where necessary.
- Match best power.

Terms Of Trading

Payment to be made not later than 25 days from statement date. Immediate credit available.

Payment Methods

Cheques should be made payable to: Signet Armorlite Europe Ltd.

Promotional Material

Promotional material (for example, posters and point of sale materials) supplied by Signet Armorlite Europe may not be altered in any way. Users of such promotional materials are authorised to insert details of the sales outlet into the appropriate section in such promotional material but are not otherwise entitled to place any additional statements or trademarks.

Promotional material supplied by Signet Armorlite Europe must be used exclusively for the sale of products manufactured or supplied by Signet Armorlite Europe.

Any promotional material supplied by Signet Armorlite Europe must be kept in good condition and only used in the United Kingdom.

Signet Armorlite Europe shall be entitled to repossess at any time any promotional material supplied by us.

Images can not be used or reproduced without prior written authorisation from Signet Armorlite. Copyright and license infringement may result as a direct consequence.

90 Day Progressive Warranty

At Signet Armorlite we offer a 90 day non-tolerance guarantee whereby we will issue a credit voucher to the monetary value of your original order. The credit voucher is valid for 12 months and can be redeemed against any of our progressive lenses. If the cost of the new order is greater you will only be charged for the difference. The 90 day guarantee is effective from the date the lenses were despatched from Signet Armorlite, and is subject to all our fitting criteria and recommendations. Signet Armorlite reserves the right to refuse credit if they believe any of the conditions have not been adhered to.

The warranty only covers genuine intolerance by the patient and does not cover prescribing or dispensing errors, changes to prescriptions, duplication or damage to lenses.



Signet Armorlite Europe

1-7 Apollo, Olympus Park
Quedgeley, Gloucester, GL2 4NF
T: 01452 720 201
F: 01452 720 004
www.saeurope.co.uk

HOW TO ORDER

CALL 01452 887 400

EMAIL orders@kodaklens.co.uk

FAX 01452 720 004

ONLINE www.saeurope.co.uk

OR CONTACT YOUR REGIONAL MANAGER

The KODAK trademark and trade dress are used under license from KODAK by Signet Armorlite, Inc. ©2016. Transitions and the swirl are registered trademarks of Transitions Optical, Inc., used under license by Transitions Optical Limited. ©2016 Transitions Optical Limited. All trademarks and registered trademarks are property of registered users.



Fresnels



3M Press-On™ Fresnel Prism and Spheres

These ultra-thin Fresnel lenses are designed for pre- and post-operative trial fittings, inexpensive vision therapy, during power changes, and for instant corrections on sports goggles and sunglasses.

The lenses, made of polyvinyl chloride, are available in 1.00D to 40.00D prisms, plus powers to 16.00D, minus powers to 14.00D and D-25 segs to +6.00D. 3M Press-On Optics, all only 1mm thick, are comfortably lightweight for patients to wear and can be easily applied to any eyewear, whether prescription or plano carrier lenses.

Use and application of D25 Segs

HORIZONTAL PLACEMENT

To ensure proper horizontal positioning of D25 Segs +3.00D and above, dot the front surface of the spectacle lens in the conventional manner to indicate the distance PD. Referring to the illustration, determine the appropriate distance between the outside edges of the segs and mark this distance on the front surface of the spectacle lenses. For example, Distance PD = 61mm and distance Rx = -3D; so the distance between the outside edge of segs should be equal to 81mm.

SEGMENT HEIGHT

If the prescribed height of the D-25 Seg requires trimming, the vertical dimension should be reduced by cutting from the bottom of the seg. This will preserve the optical correction of the D-25 Seg. Place a razor blade at the desired position on the segment and press straight down against a flat, hard surface to obtain a sharp edge.

Each package contains both right and left seg. Be sure the optical centre of each seg is decentred nasalward. The optical centre of each seg is easily identified by the position of the smallest concentric circle in each segment. Normally the top edges of the segs should be level with each other.

Prism	Plus Power	Minus Power	FT25 (D-Seg)
1.00	0.50	1.00	1.00
2.00	1.00	2.00	1.50
3.00	1.50	3.00	2.00
4.00	2.00	4.00	2.50
5.00	2.50	5.00	3.00
6.00	3.00	6.00	4.00
7.00	3.50	7.00	5.00
8.00	4.00	8.00	6.00
9.00	5.00	9.00	
10.00	6.00	10.00	
12.00	7.00	11.00	
15.00	8.00	12.00	
20.00	10.00	13.00	
25.00	12.00	14.00	
30.00	14.00		
35.00	16.00		
40.00			

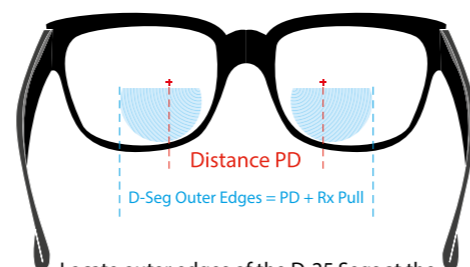

Locate outer edges of the D-25 Segs at the patient's PD pull the following amount:

Distance Rx	Rx Pull
-8.00 to -6.00D	23mm
-6.00 to -0.00D	20mm
0.00D to +4.00	16mm
+4.00 to +8.00	11mm

Application of 3M Press-On™ Optics

QUICK AND EASY TO APPLY

Both sphere and prism Press-on Optics can be applied to either part of or the entire lens. Avoid exposing Press-on optics to dust, dirt or grease during application.

1) With a felt tip pen, mark the optical centre onto the lens. This is important with sphere placement only. The optical centre is the smallest concentric ring. The base orientation of the optic is indicated with the word 'base'. Position the Press-On Optic with the optical centre aligned and the smooth side down facing the inside surface of the spectacles.

2a) If the lens is out of the frame; with scissors, cut the Press-On Optic to the size of the lens. With a razor blade held at the angle of the bevel, carefully trim the Press-on optic flush with the edge of the spectacle lens.

2b) If the lens is in a frame; with a felt tip pen, trace the lens onto the Press-On Optic just inside the rim of the frame. Remove the Press-On Optic from the spectacle lens and carefully cut out the Press-On Optic inside the line.

Note: the Press-On Optic, after cutting, must not overlap the bevel or touch the frame.

3) Wash the spectacle lens and the Press-On Optic with a weak solution of dish washing detergent (free of lotion) to remove grease and dirt. Rinse thoroughly. Submerge the spectacles and Press-On Optic in a bowl of warm water or under a running tap. Wipe away any air bubbles clinging to either surface.

4) Reposition the Press-on Optics and remove the spectacles from the water, holding the Press-On Optic in place. Adjustments can be made by sliding the Press-On Optic. Press dry.

Note: when applying to a plastic lens, the Press-On Optic may be difficult to slide. Repositioning may require removal and reapplication.

5) If the lenses are out of the frame, reinsert into the frame.

6) Inspect the edges to check no overlapping occurs onto the frames. Remove and reapply if dust or air bubbles are trapped between the Press-On Optic and the lens. Handle spectacles gently for 24hrs following application. Faint, grey patches that may develop are temporary and usually disappear as drying is completed.

Note: Alcohol is not recommended for repeated application of the optics.

FRESNEL BENEFITS

- Suitable for use with most eyewear
- No minimum order quantity
- Quick and easy to apply
- Next day delivery for orders placed before 4pm
- Comfortable and lightweight only 1mm thick



Signet Armorlite Europe

1-7 Apollo, Olympus Park
Quedgeley, Gloucester, GL2 4NF
T: 01452 720 201
F: 01452 720 004
www.saeurope.co.uk

HOW TO ORDER

CALL 01452 887 400

EMAIL orders@kodaklens.co.uk

FAX 01452 720 004

ONLINE via Orinoco

OR CONTACT YOUR REGIONAL MANAGER

The KODAK trademark and trade dress are used under license from KODAK by Signet Armorlite, Inc. ©2016. Transitions and the swirl are registered trademarks of Transitions Optical, Inc., used under license by Transitions Optical Limited. ©2016 Transitions Optical Limited. All trademarks and registered trademarks are property of registered users.

**SEE THE
COLOURS
OF LIFE**

